

Panasonic®

Basic Operating Instructions

Digital Camera

Model No. **DMC-FZ2000**



LUMIX

Please read these instructions carefully before using this product, and save this manual for future use.

More detailed operating instructions are available in “Operating Instructions for advanced features (PDF format)”. To read it, download it from the website. (P70)

Web Site: <http://www.panasonic.com>

Model number suffix “EB” denotes UK model.

DVQX1043ZA

F0916KD0

EB

Dear Customer,

We would like to take this opportunity to thank you for purchasing this Panasonic Digital Camera. Please read these Operating Instructions carefully and keep them handy for future reference. Please note that the actual controls and components, menu items, etc. of your Digital Camera may look somewhat different from those shown in the illustrations in these Operating Instructions.

Carefully observe copyright laws.

- Recording of pre-recorded tapes or discs or other published or broadcast material for purposes other than your own private use may infringe copyright laws. Even for the purpose of private use, recording of certain material may be restricted.

Information for Your Safety

WARNING:

To reduce the risk of fire, electric shock or product damage,

- Do not expose this unit to rain, moisture, dripping or splashing.
- Use only the recommended accessories.
- Do not remove covers.
- Do not repair this unit by yourself. Refer servicing to qualified service personnel.

The socket outlet shall be installed near the equipment and shall be easily accessible.

■ Product identification marking

Product	Location
Digital Camera	Bottom
Battery charger	Bottom



Declaration of Conformity (DoC)

Hereby, "Panasonic Corporation" declares that this product is in compliance with the essential requirements and other relevant provisions of Directive 1999/5/EC. Customers can download a copy of the original DoC to our R&TTE products from our DoC server:

<http://www.doc.panasonic.de>

Contact to Authorized Representative:

Panasonic Marketing Europe GmbH, Panasonic Testing Centre, Winsbergring 15, 22525 Hamburg, Germany

This product on purpose to connect to access point of 2.4 GHz WLAN.

■ About the battery pack

CAUTION

- Danger of explosion if battery is incorrectly replaced. Replace only with the type recommended by the manufacturer.
- When disposing of the batteries, please contact your local authorities or dealer and ask for the correct method of disposal.

- Do not heat or expose to flame.
- Do not leave the battery(ies) in a car exposed to direct sunlight for a long period of time with doors and windows closed.

Warning

Risk of fire, explosion and burns. Do not disassemble, heat above 60 °C or incinerate.

■ About the battery charger

CAUTION!

To reduce the risk of fire, electric shock or product damage,



- **Do not install or place this unit in a bookcase, built-in cabinet or in another confined space. Ensure this unit is well ventilated.**

- The battery charger is in the standby condition when the AC power supply cord is connected. The primary circuit is always "live" as long as the power cord is connected to an electrical outlet.

Caution for AC mains lead

For your safety, please read the following text carefully.

This appliance is supplied with a moulded three pin mains plug for your safety and convenience.

A 5-ampere fuse is fitted in this plug. Should the fuse need to be replaced please ensure that the replacement fuse has a rating of 5-ampere and that it is approved by ASTA or BSI to BS1362. Check for the ASTA mark  or the BSI mark  on the body of the fuse.

If the plug contains a removable fuse cover you must ensure that it is refitted when the fuse is replaced.

If you lose the fuse cover the plug must not be used until a replacement cover is obtained.

A replacement fuse cover can be purchased from your local dealer.

■ Before use

Remove the connector cover.

■ How to replace the fuse

The location of the fuse differ according to the type of AC mains plug (figures A and B). Confirm the AC mains plug fitted and follow the instructions below.

Illustrations may differ from actual AC mains plug.

1. Open the fuse cover with a screwdriver.

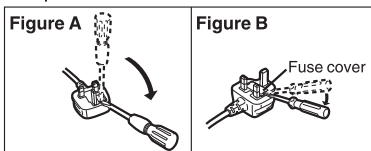

2. Replace the fuse and close or attach the fuse cover.

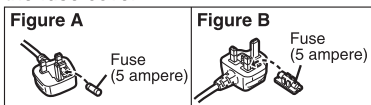

Cautions for Use

- Do not use any other USB connection cables except the supplied one.
- Use a "High Speed HDMI micro cable" with the HDMI logo.
Cables that do not comply with the HDMI standards will not work.
"High Speed HDMI micro cable" (Type D–Type A plug, up to 2 m (6.6 feet) long)
- Always use a genuine Panasonic shutter remote control (DMW-RSL1: optional).

Keep this unit as far away as possible from electromagnetic equipment (such as microwave ovens, TVs, video games etc.).

- If you use this unit on top of or near a TV, the pictures and/or sound on this unit may be disrupted by electromagnetic wave radiation.
- Do not use this unit near cell phones because doing so may result in noise adversely affecting the pictures and/or sound.
- Recorded data may be damaged, or pictures may be distorted, by strong magnetic fields created by speakers or large motors.
- Electromagnetic wave radiation may adversely affect this unit, disturbing the pictures and/or sound.
- If this unit is adversely affected by electromagnetic equipment and stops functioning properly, turn this unit off and remove the battery or disconnect AC adaptor (DMW-AC10E: optional).
Then reinsert the battery or reconnect AC adaptor and turn this unit on.

Do not use this unit near radio transmitters or high-voltage lines.

- If you record near radio transmitters or high-voltage lines, the recorded pictures and/or sound may be adversely affected.

-
- Before cleaning the camera, remove the battery or the DC coupler (DMW-DCC8: optional), or disconnect the power plug from the outlet.
 - Do not press the monitor with excessive force.
 - Do not press the lens with excessive force.
 - Do not spray the camera with insecticides or volatile chemicals.
 - Do not keep rubber or plastic products in contact with the camera for a long period of time.
 - Do not use solvents such as benzine, thinner, alcohol, kitchen detergents, etc., to clean the camera, since it may deteriorate the external case or the coating may peel off.
 - Do not leave the camera with the lens facing the sun, as rays of light from the sun may cause it to malfunction.
 - Always use the supplied cords and cables.
 - Do not extend the cords or the cables.
 - During access (image writing, reading and deleting, formatting etc.), do not turn this unit off, remove the battery, card or disconnect the AC adaptor (DMW-AC10E: optional). Furthermore, do not subject the camera to vibration, impact or static electricity.
 - The data on the card may be damaged or lost due to electromagnetic waves, static electricity or breakdown of the camera or the card. We recommend storing important data on a PC etc.
 - Do not format the card on your PC or other equipment. Format it on the camera only to ensure proper operation.
-
- The battery is not charged when the camera is shipped. Charge the battery before use.
 - The battery is a rechargeable lithium ion battery. If the temperature is too high or too low, the operating time of the battery will become shorter.
 - The battery becomes warm after using and during and after charging. The camera also becomes warm during use. This is not a malfunction.
 - Do not leave any metal items (such as clips) near the contact areas of the power plug or near the batteries.
 - Store the battery in a cool and dry place with a relatively stable temperature: [Recommended temperature: 15 °C to 25 °C (59 °F to 77 °F), Recommended humidity: 40%RH to 60%RH]
 - Do not store the battery for a long time while fully charged. When storing the battery for a long period of time, we recommend charging it once a year. Remove the battery from the camera and store it again after it has completely discharged.
-

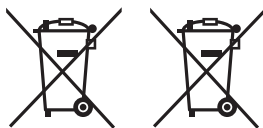

These symbols indicate separate collection of waste electrical and electronic equipment or waste batteries. More detailed information is contained in "Operating Instructions for advanced features (PDF format)".

Contents

Information for Your Safety	2
-----------------------------------	---

Preparation/Basic

Care of the camera	7
Standard Accessories	8
Names and Functions of Components	9
About cards that can be used with this unit	11
Preparations before Recording	12
Basic Operations	17
Setting menu items	22
Calling frequently-used menus instantly (Quick Menu)	23
Assigning frequently used functions to the buttons (function buttons)	23

Recording

Taking Pictures using the Automatic Function (Intelligent Auto Mode)	24
Adjusting Focus Manually	25
Taking Close-up Pictures	27
Select a Drive Mode	27
Recording 4K Photos	28
Controlling Focus After Recording (Post Focus/Focus Stacking)	30
Taking Pictures While Adjusting a Setting Automatically (Bracket Recording)	33
Image Stabiliser	35
Zoom types and use	35
Recording Motion Picture/ 4K Motion Picture	36
Recording Motion Pictures Using Various Effects and Advanced Settings (Creative Video Mode)	39

Playback

Playing Back Pictures	45
Playing Back Motion Pictures	45
Deleting Pictures	46

Menu

Menu list	47
-----------------	----

Wi-Fi

What you can do with the Wi-Fi® function	52
Controlling with a Smartphone/ Tablet	53

Others

Downloading software	57
Monitor Display/Viewfinder Display	58
Troubleshooting	62
Specifications	66
Digital Camera Accessory System	69
Reading the Operating Instructions (PDF format)	70

Care of the camera

Do not subject to strong vibration, shock, or pressure.

- The lens, monitor, or external case may be damaged if used in the following conditions. It may also malfunction or image may not be recorded if you:
 - Drop or hit the camera.
 - Press hard on the lens or the monitor.

Do not hold the lens barrel as you take pictures. There is a risk that your finger will be trapped as the lens retracts.

This camera is not dust/drip/water proof.

Avoid using the camera in places with a lot of dust, water, sand, etc.

- Liquid, sand and other foreign material may get into the space around the lens, buttons, etc. Be particularly careful since it may not just cause malfunctions, but it may also become irreparable.
 - Places with a lot of sand or dust.
 - Places where water can come into contact with this unit, such as when using it on a rainy day or at the beach.

If sand, dust, or liquids such as water droplets adhere to the monitor, wipe them off with a dry soft cloth.

- Not doing so may cause the monitor to respond incorrectly to touch operations.
- If the monitor is closed when such liquids are present, malfunction may result.

Keep objects sensitive to magnetic fields (credit cards, etc.) away from the camera. Otherwise, magnetic fields may damage their data and make them unusable.

■ About Condensation (When the lens, the viewfinder or monitor is fogged up)

- Condensation occurs when the ambient temperature or humidity changes. Be careful of condensation since it causes lens, viewfinder and monitor stains, fungus and camera malfunction.
- If condensation occurs, turn the camera off and leave it for about 2 hours. The fog will disappear naturally when the temperature of the camera becomes close to the ambient temperature.

Standard Accessories

Check that all the accessories are supplied before using the camera.
Product numbers correct as of September 2016. These may be subject to change.

1	Battery Pack (Indicated as battery pack or battery in the text) Charge the battery before use.
2	Battery Charger (Indicated as battery charger or charger in the text)
3	AC mains Lead
4	Lens Hood
5	Lens Cap/ Lens cap string
6	USB Connection Cable
7	Shoulder Strap
8	Hot shoe cover • This is attached to the camera at the time of purchase.

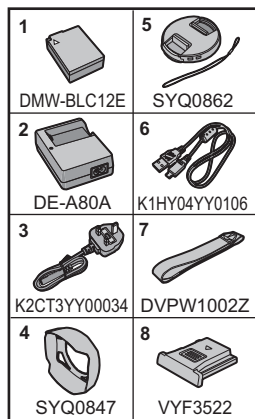

- SD Memory Card, SDHC Memory Card and SDXC Memory Card are indicated as **card** in the text.
- **The card is optional.**
- Consult the dealer or Panasonic if you lose the supplied accessories. (You can purchase the accessories separately.)

Names and Functions of Components

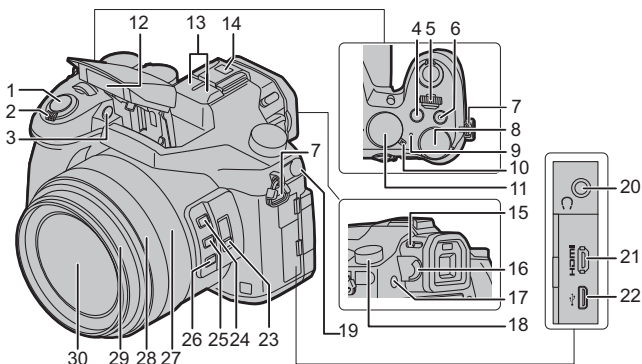

1	Shutter button (P18)	18	Drive mode dial (P27)
2	Zoom lever (P18)	19	[MIC] socket
3	Self-timer indicator/ AF Assist Lamp		Headphone socket
4	[] (Exposure Compensation) button/ [Fn4] button (P23)	20	• Excessive sound pressure from earphones and headphones can cause hearing loss.
5	Front dial (P20)	21	[HDMI] socket
6	Motion picture button (P36)	22	USB socket
7	Shoulder strap eyelet (P13)	23	[ND FILTER] switch (P21)
8	Rear dial (P20)	24	[Fn1] button (P23)
9	Status indicator (P16)/ Wi-Fi® connection lamp (P52)	25	[Fn2] button (P23)
10	Camera ON/OFF switch (P16)	26	[Fn3] button (P23)
11	Mode dial (P19)	27	Zoom ring (P18)
12	Flash	28	Focus ring (P26)
13	Stereo microphone • Be careful not to cover the microphone with your finger. Doing so may make sound difficult to record.	29	Lens barrel
14	Hot shoe (Hot shoe cover) • Keep the Hot Shoe Cover out of reach of children to prevent swallowing.	30	Lens surface
15	Flash open lever • The flash opens, and recording with the flash becomes possible.		
16	Diopter adjustment dial (P18)		
17	[LVF] button (P17)/[Fn7] button (P23)		

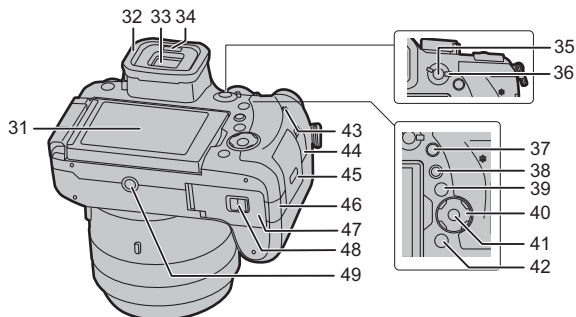

31	Touch screen (P21)/monitor (P58)
32	Eyecup
33	Viewfinder (P17)
34	Eye sensor (P17)
35	[AF/AE LOCK] button
36	Focus mode lever
37	[Q.MENU] button (P23)/[Fn5] button (P23)
38	[▶] (Playback) button (P45)
39	[DISP.] button • Each time this is pressed, the display on the monitor is switched.
	Cursor buttons (P19)
	▲/[ISO] (ISO sensitivity)
40	▶/[WB] (White Balance)
	◀/[AF] (Auto Focus Mode)
	▼/[AF] (AF Macro) (P27)
41	[MENU/SET] button (P19)
42	[X/↵] (Delete/Cancel) button (P46)/[Fn6] button (P23)
43	Speaker
44	[REMOTE] socket
45	Card door (P15)

- 46** DC coupler cover (P69)
- When using an AC adaptor, ensure that the Panasonic DC coupler (DMW-DCC8: optional) and AC adaptor (DMW-AC10E: optional) are used.
 - Always use a genuine Panasonic AC adaptor (DMW-AC10E: optional).
 - When using an AC adaptor, use the AC mains Lead supplied with the AC adaptor.

47 Battery door (P14)

48 Release lever (P14)

- 49** Tripod mount
- It may not be possible to attach and securely fasten a tripod with a screw length of 5.5 mm (0.22 inch) or more to the camera. Doing so may also damage the camera.

■ About the function button ([Fn8] to [Fn12])

- Function buttons ([Fn8] to [Fn12]) (P23) are touch icons. Touch the [F] tab on the recording screen to display them.

■ Removing the Hot Shoe Cover

The camera comes with a hot shoe cover attached to the hot shoe.

Remove the hot shoe cover by pulling it in the direction indicated by

arrow ② while pressing it in the direction indicated by arrow ①.

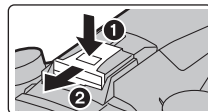











About cards that can be used with this unit

SD Memory Card (512 MB to 2 GB)	<ul style="list-style-type: none"> This unit is compatible with UHS-I UHS Speed Class 3 standard SDHC/SDXC memory cards. Operation of the cards on the left has been confirmed with Panasonic's cards.
SDHC Memory Card (4 GB to 32 GB)	
SDXC Memory Card (48 GB to 128 GB)	

■ About motion picture/4K photo recording and speed class ratings

Use a card that meets the following ratings of the SD Speed Class or UHS Speed Class.

[Rec Format]	Bit rate in [Rec Quality]	Speed class	Label example
[AVCHD]	All	Class 4 or higher	CLASS  
[MP4]	100 Mbps	UHS Speed Class 3	
	28 Mbps or lower	Class 4 or higher	CLASS  
[MP4 (LPCM)]/ [MOV]	100 Mbps or higher	UHS Speed Class 3	
	50 Mbps	UHS Speed Class 1 or higher	
		Class 10	CLASS  
When recording in 4K Photo / [Post Focus]		UHS Speed Class 3	

- SD Speed Class and UHS Speed Class are the speed standards regarding continuous writing. To check the class, see the labelled side, etc. of the card.
- Please confirm the latest information on the following website.
<http://panasonic.jp/support/global/cs/dsc/>
(This Site is English only.)
- Keep the Memory Card out of reach of children to prevent swallowing.

Preparations before Recording

Attaching the Lens Hood

- Do not hold the lens hood in a way that twists or bends it.
- Check that the camera is turned off.
- Close the flash.

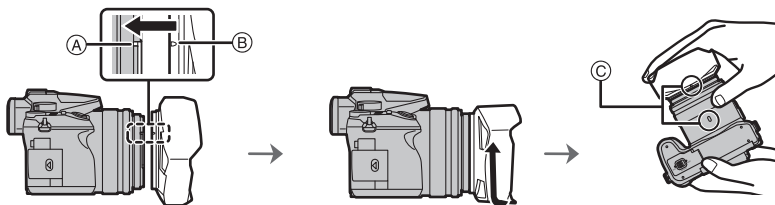

- 1 Align the mounting mark on the lens hood slightly above the mounting projection on the edge of the lens.**
 - Ⓐ Mounting projection (Lens edge)
 - Ⓑ Mounting mark (Lens hood)
- 2 Screw in the lens hood in the direction of the arrow.**
- 3 Continue to rotate the lens hood until you hear a “click” even if you feel some stiffness, and then align the mark on the bottom of the camera.**
 - Ⓒ Rotate until the marks are aligned
 - Check that the lens hood is firmly attached and that it does not appear in the picture.

- When temporarily detaching and carrying the lens hood, we recommend attaching with the orientation reversed. Return it to the normal direction when taking pictures.
- **Be careful not to catch your finger, etc. when the lens retracts.**
- When taking pictures with flash with the lens hood attached, the lower portion of the photo may turn dark (vignetting effect) and the control of the flash may be disabled because the photo flash may be obscured by the lens hood. We recommend detaching the lens hood.

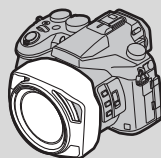

Attaching the Lens Cap

- When you turn the camera off or carry the camera, attach the lens cap to protect the surface of the lens.
- Do not hang or swing around the camera with the lens cap string.
- Make sure to detach the lens cap when turning this unit on.
- **Be careful that the lens cap string does not become entangled with the shoulder strap.**

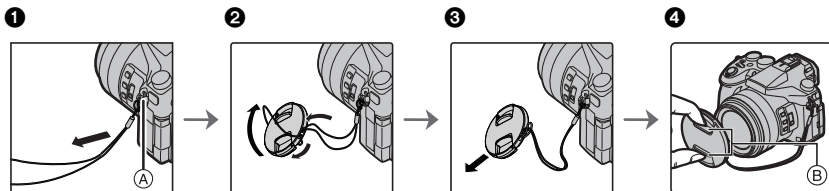

- (A) Shoulder strap eyelet
 (B) Pinch here to attach or detach the cap.

- 1 Pass the string through the hole on the camera.
- 2 Pass the string through the lens cap, and then pass the lens cap through the loop formed by the string.
- 3 Fasten the string.
- 4 Attach the lens cap.

Attaching the Shoulder Strap

- **We recommend attaching the shoulder strap when using the camera to prevent it from dropping.**

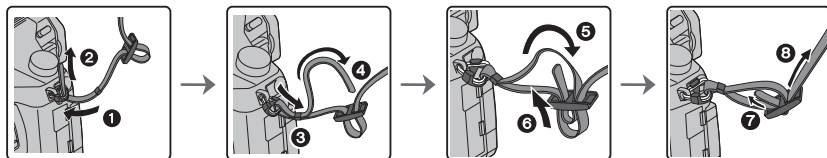

- Perform steps 1 to 8 and then attach the other side of the shoulder strap.
- Use the shoulder strap around your shoulder.
 - Do not wrap the strap around your neck.
 - It may result in injury or accident.
- Do not leave the shoulder strap where an infant can reach it.
 - It may result in an accident by mistakenly wrapping around the neck.

Charging the Battery

The battery that can be used with this unit is **DMW-BLC12E**.

- 1 Attach the battery paying attention to the direction of the battery.
- 2 Connect the AC mains Lead.
 - The [CHARGE] indicator (A) lights up and charging begins.

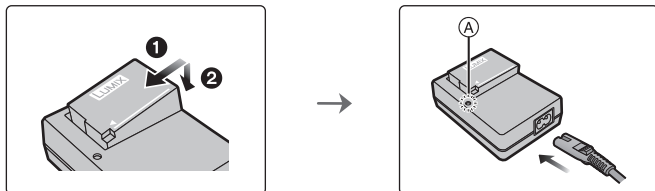

■ About the [CHARGE] indicator

On: Charging.

Off: Charging has completed.

(Disconnect the charger from the electrical socket and detach the battery after charging is completed.)

• When the [CHARGE] indicator flashes

- The battery temperature is too high or too low. It is recommended to charge the battery again in an ambient temperature of between 10 °C and 30 °C (50 °F and 86 °F).
- The terminals of the charger or the battery are dirty. In this case, wipe them with a dry cloth.

■ Charging time

Charging time

Approx. 140 min

- The indicated charging time is for when the battery has been discharged completely. The charging time may vary depending on how the battery has been used. The charging time for the battery in hot/cold environments or a battery that has not been used for a long time may be longer than normal.

Inserting the Battery

- Always use genuine Panasonic batteries (DMW-BLC12E).
- If you use other batteries, we cannot guarantee the quality of this product.

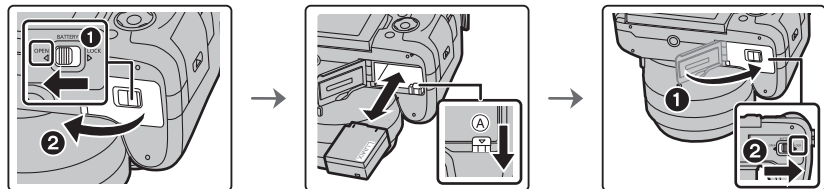

- Being careful about the battery orientation, insert all the way until you hear a locking sound and then check that it is locked by lever (A). Pull the lever (A) in the direction of the arrow to remove the battery.

Inserting the Card (Optional)

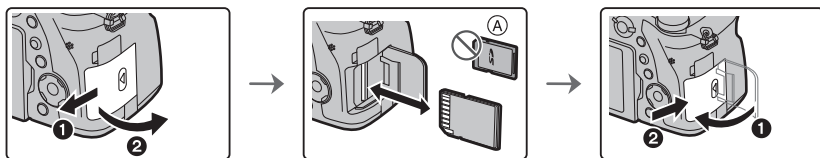

(A) Check the orientation of the card.

- Push it securely all the way until you hear a “click” while being careful about the direction in which you insert it.

To remove the card, push the card until it clicks, then pull the card out upright.

Monitor

At the time when this camera is purchased, the monitor is stowed in the camera body. Bring out the monitor as shown below.

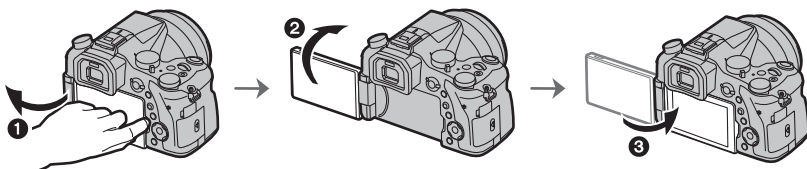

❶ Open the monitor. (Maximum 180°)

❷ It can be rotated 180° forwards.

❸ Return the monitor to its original position.

- **Only rotate the monitor after opening it wide enough, and be careful not to use excessive force as it may be damaged.**

- When not using the monitor it is recommended that you close it with the screen facing inward to prevent dirt and scratches.

Setting Date/Time (Clock Set)

- The clock is not set when the camera is shipped.

- 1 Turn the camera on.
 - When the camera is turned on, the status indicator **1** lights up green.
- 2 Press [MENU/SET].
- 3 Press ◀/▶ to select the items (year, month, day, hour, minute), and press ▲/▼ to set.
- 4 Press [MENU/SET] to set.
- 5 When [The clock setting has been completed.] is displayed, press [MENU/SET].
- 6 When [Please set the home area] is displayed, press [MENU/SET].
- 7 Press ◀/▶ to select the home area, and then press [MENU/SET].

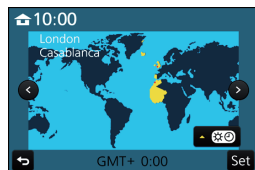
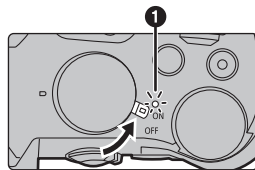

Formatting the card (initialisation)

Format the card before recording a picture with this unit.

Since data cannot be recovered after formatting, make sure to back up necessary data in advance.

MENU → **Setup** → **Format**

Basic Operations

Tips for taking good pictures

Hold the camera gently with both hands, keep your arms still at your side and stand with your feet slightly apart.

- Make sure your footing is stable and there is no danger of colliding with another person or object in the vicinity while taking pictures.

- Do not cover the flash, AF Assist lamp (A), microphone (B), or speaker (C) with your fingers or other objects.

- Do not hold the lens barrel as you take pictures. There is a risk that your finger will be trapped as the lens retracts.

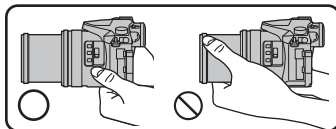
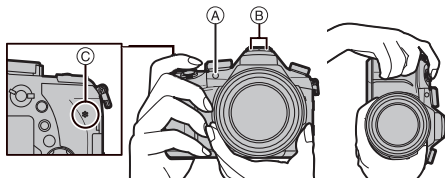

[LVF] button (Switching the Monitor/Viewfinder)

Press [LVF] to switch between the Monitor and Viewfinder.

- (A) [LVF] button
- (B) Eye sensor

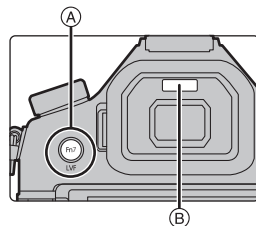

Press [LVF].

- The monitor/viewfinder will switch as follows:

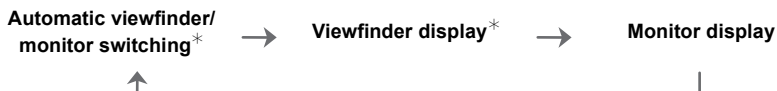

* If [Eye Sensor AF] in the [Custom] menu is set to [ON], the camera automatically adjusts the focus as the eye sensor is activated. The camera does not beep when focus is achieved with [Eye Sensor AF].

■ Notes on automatic viewfinder/monitor switching

Automatic viewfinder/monitor switching enables the eye sensor to switch the display to the viewfinder automatically when you bring your eye or an object near it.

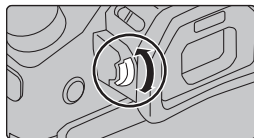

■ Diopter adjustment

Adjust the diopter to suit your vision so that you can see the characters displayed in the viewfinder clearly.

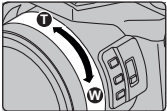
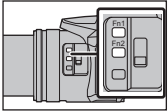
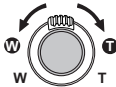

Zoom operations

You can zoom-out to record landscapes etc. in wide angle (Wide) or zoom-in to make people and objects appear closer (Tele).

With the zoom ring	With the slow zoom
Rotate the zoom ring. 	Press [Fn1] or [Fn2]. <ul style="list-style-type: none"> You can zoom in at a speed slower than the normal zoom speed. By default, [Slow Zoom T] is assigned to [Fn1] and [Slow Zoom W] is assigned to [Fn2]. You can change the operation and settings of slow zoom in [Slow Zoom Button Setting], [Slow Zoom Speed] and [Soft Zoom] in the [Custom] menu. 
With the zoom lever	
Rotate the zoom lever. 	Turning angle is large: Zoom speed is high Turning angle is small: Zoom speed is low <ul style="list-style-type: none"> The operation of the zoom lever is denoted as shown below in these operating instructions. Rotate the zoom lever: 

Taking pictures

1 Press the shutter button halfway to focus.

- (A) Aperture value
- (B) Shutter speed
- (C) Focus indication

- Aperture value and shutter speed are displayed. (It will flash in red if the correct exposure is not achieved, except when set to flash.)
- Once the subject is in focus, the focus indication is displayed. (When the subject is not in focus, the indication flashes.)

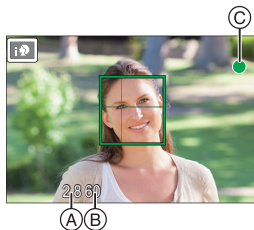
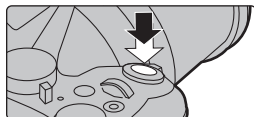

- 2 Press the shutter button fully (push it in further), and take the picture.

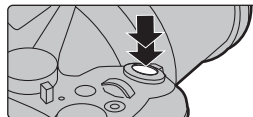

- Be careful not to move the camera when you press the shutter button.
- Pictures cannot be taken until focus is achieved when [Focus/Release Priority] is set to [FOCUS].

Check the picture you have taken

- The [Auto Review] function displays the picture you have just taken.
- To display the picture in Playback Mode, press [▶].



Cursor buttons/[MENU/SET] button

Pressing the cursor button:

Selection of items or setting of values etc., is performed.

Pressing [MENU/SET]:

Confirmation of setting contents, etc., is performed.

- These operating instructions express the up, down, left, and right of the cursor button as ▲/▼/◀/▶.

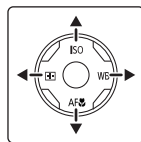





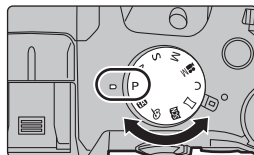

Mode dial (Selecting a Recording Mode)

Select the mode by rotating the mode dial.

- Rotate the mode dial slowly to select the desired mode.



	<p>Intelligent Auto Mode (P24) The subjects are recorded using settings automatically selected by the camera.</p>
	<p>Intelligent Auto Plus Mode (P24) Allows you to adjust the brightness and colour hue when in Intelligent Auto Mode.</p>

P	Programme AE Mode Records at the aperture value and shutter speed set by the camera.
A	Aperture-Priority AE Mode The shutter speed is automatically determined by the aperture value you set.
S	Shutter-Priority AE Mode The aperture value is automatically determined by the shutter speed you set.
M	Manual Exposure Mode The exposure is adjusted by the aperture value and the shutter speed which are manually adjusted.
	Creative Video Mode This mode allows you to record motion pictures with effects such as [Slow/Quick] and [Dolly Zoom]. (P39)
C	Custom Mode Use this mode to take pictures with previously registered settings.
	Panorama Shot Mode This mode allows you to take panorama pictures.
	Scene Guide Mode This mode allows you to take pictures that match the scene being recorded.
	Creative Control Mode Record while checking the image effect.

Front Dial/Rear Dial



Rotating:

Selection of items or setting of values is performed during the various settings.

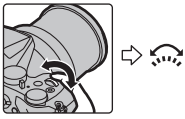
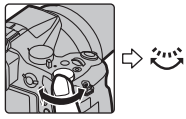
• These operating instructions describe operations of the front dial/rear dial as follows:

e.g.: When rotating the front dial to the left or right		e.g.: When rotating the rear dial to the left or right	
---------------------------------------------------------	-----------------------------------------------------------------------------------	--------------------------------------------------------	-----------------------------------------------------------------------------------

Allows you to set the aperture, shutter speed, and other settings when in **P / A / S / M** modes.

Mode dial	 Front dial	 Rear Dial
P	Programme Shift	Programme Shift
A	Aperture value	Aperture value
S	Shutter speed	Shutter speed
M	Aperture value	Shutter speed

[ND FILTER] switch (switching the ND filter setting)

Using the [ND FILTER] switch, you can switch the built-in optical ND filter setting. (The filter adjusts the amount of light.)

- Use this function when recording a bright subject outdoors under a clear sky that causes the screen to look white.

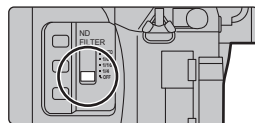

[AUTO]	Controls the ND filter automatically according to the recording condition.
[1/4]	Reduces the amount of light to 1/4.
[1/16]	Reduces the amount of light to 1/16.
[1/64]	Reduces the amount of light to 1/64.
[OFF]	Does not use the ND filter.

Touch screen (Touch operations)

Touch screen of this unit is capacitive. Touch the panel directly with your bare finger.

■ Touch

To touch and release the touch screen.

- When selecting features using the touch screen, be sure to touch the centre of the desired icon.



■ Drag

A movement without releasing the touch screen.

This can also be used to move to the next image during playback, etc.

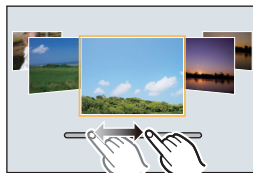

■ Pinch (enlarge/reduce)

Pinch the touch screen apart (enlarge) or together (reduce) with two fingers.

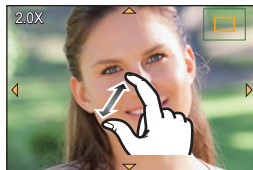

Setting menu items

1 Press [MENU/SET].

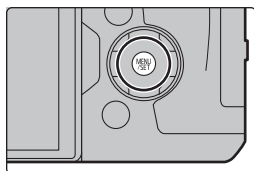

2 Press ▲/▼ of the cursor button to select the menu item and press [MENU/SET].

3 Press ▲/▼ of the cursor button to select the setting and press [MENU/SET].

- Depending on the menu item, its setting may not appear or it may be displayed in a different way.



■ Switching to other menus

1 Press ◀.

2 Press ▲/▼ to select a menu selector icon, such as [⌘].

- You can also select the menu toggle icons by rotating the front dial.

3 Press [MENU/SET].



■ Close the menu

Press [⏪/⏩] or press the shutter button halfway.

Calling frequently-used menus instantly

(Quick Menu)

By using the Quick Menu, some of the menu settings can be easily found.

- 1 Press [Q.MENU] to display the Quick Menu.
- 2 Rotate the front dial to select the menu item.
- 3 Rotate the rear dial to select the setting.
- 4 Press [Q.MENU] to exit the menu once the setting is complete.

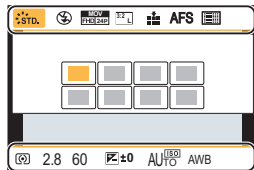

Assigning frequently used functions to the buttons (function buttons)

You can assign recording functions, etc. to specific buttons and icons.

- Some functions cannot be assigned depending on the function button.

- 1 Select the menu. (P22)

MENU → **fC [Custom]** → **[Fn Button Set]** → **[Setting in REC mode]/[Setting in PLAY mode]**

- 2 Press ▲/▼ to select the function button you want to assign a function to and then press [MENU/SET].
- 3 Press ▲/▼ to select the function you want to assign and then press [MENU/SET].

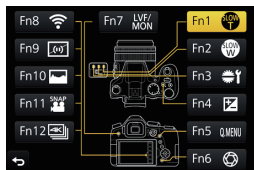

Taking Pictures using the Automatic Function

(Intelligent Auto Mode)

Recording Mode:  

In this mode, the camera makes the optimal settings for the subject and scene, so we recommend it when you wish to leave the settings to the camera and record without thinking about them.

1 Set the mode dial to .

- The camera will switch to either the most recently used of Intelligent Auto Mode or Intelligent Auto Plus Mode. At the time of purchase, the mode is set to Intelligent Auto Plus Mode. (P24)

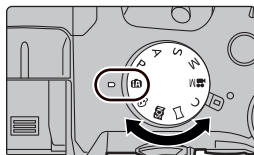





2 Align the screen with the subject.

- When the camera identifies the optimum scene, the icon of the scene concerned is displayed in blue for 2 seconds, after which its colour changes to the usual red. (Automatic scene detection)



- When [iHandheld Night Shot] is set to [ON] and  is detected while taking handheld night shots, pictures of the night scenery will be taken at a high burst speed and composed into a single picture.
- When [iHDR] is set to [ON] and there is, for example, strong contrast between the background and the subject, multiple still pictures are recorded with differing exposures and combined to create a single still picture rich in gradation.

■ Switching between Intelligent Auto Plus Mode and Intelligent Auto Mode

Select the  or  tab on the menu screen, press **▶** to select  or , and press [MENU/SET].

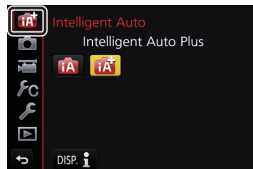

Taking pictures with customised colour defocus control, and brightness settings

Recording Mode: 

■ Setting colour

- 1 Press  to display the setting screen.
- 2 Rotate the rear dial to adjust colour.
 - Press [MENU/SET] to return to the recording screen.







■ Taking a picture with a blurred background (Defocus Control)

- 1 Press [Fn6] to display the setting screen.
- 2 Set the blurriness by rotating the rear dial.
 - If you press [MENU/SET], you can return to the recording screen.
 - Pressing [Fn6] on the blurriness setting screen will cancel the setting.



■ Setting brightness

- 1 Press [].
- 2 Rotate the rear dial to adjust brightness.
 - You can adjust the Exposure Bracket setting by pressing / while the brightness setting screen is displayed. (P34)
 - Press [] again to return to the recording screen.

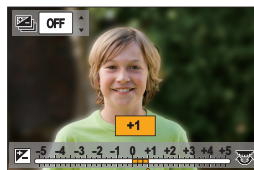

Adjusting Focus Manually

Applicable modes:         

Use this function when you want to fix the focus or when the distance between the lens and the subject is determined and you do not want to activate Auto Focus.

1 Set the focus mode lever to [MF].

2 Press ◀ ([MF]).

3 Press ▲/▼/◀/▶ to determine the area to be enlarged, and press [MENU/SET].

- The assist screen is displayed, enlarging the area. (MF Assist)
- You can also adjust the focus position by dragging (P21) the screen.
- Pressing [DISP.] resets the focus position back to the centre.

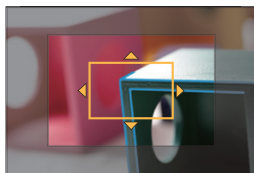

4 Operate the focus ring to set the focus.

Rotate to A side:

Focuses on nearby subject

Rotate to B side:

Focuses on faraway subject

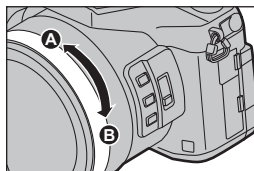

Ⓐ MF Assist (enlarged screen)



Ⓑ Peaking

Ⓒ MF Guide

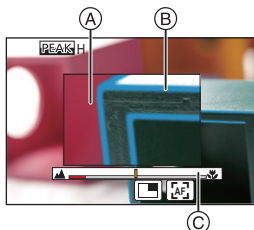
- The in-focus portions will be highlighted. (Peaking)
- You can check whether the point of focus is to the near side or to the far side. (MF Guide)



You can perform the following operations:

Button operation	Touch operation	Description of operation
▲/▼/◀/▶	Dragging	Moves the enlarged area
	Pinching out/in	Enlarges/reduces the screen in small steps.
	—	Enlarges/reduces the screen in large steps.
—		Switches the enlarged display (windowed/full screen)
[DISP.]	[Reset]	Resets the area to be enlarged back to the centre.

5 Press the shutter button halfway.

- The assist screen will close. The recording screen will be displayed.
- You can also close the assist screen by pressing [MENU/SET].



Taking Close-up Pictures

Applicable modes:   **P A S M**   

This mode allows you to take close-up pictures of a subject, e.g. when taking pictures of flowers.

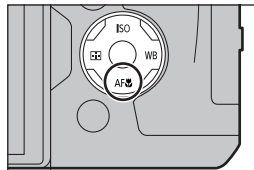
- 1 Press **▼** [**AF** ].
- 2 Press **◀/▶** to select the item and then press [**MENU/SET**].



[AF ] ([AF Macro])	You can take pictures of a subject as close as 3 cm (0.098 feet) from the lens by rotating the zoom lever upmost to Wide (1×).
[] ([Macro Zoom])	Use this setting to get close to the subject and then further enlarge when taking the picture. You can take a picture with the Digital Zoom up to 3× while maintaining the distance to the subject for the extreme Wide position (3 cm (0.098 feet)). • The image quality is poorer than during normal recording. • Zoom range will be displayed in blue. (digital zoom range)
[ OFF] ([Off])	—





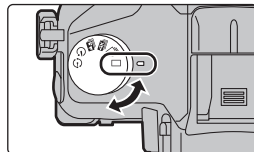

Select a Drive Mode

Applicable modes:   **P A S M**   

You can change what the camera will do when you press the shutter button.

Rotating the drive mode dial.



 [Single]	When the shutter button is pressed, only one picture is recorded.
 [Burst]	Recordings are made in succession while the shutter button is pressed.
 [4K PHOTO] (P28)	When the shutter button is pressed, a 4K photo is recorded.
 [Post Focus] (P30)	When the shutter button is pressed, Post Focus recording is performed.
 [Self Timer]	When the shutter button is pressed, recording takes place after the set time has elapsed.
 [Time Lapse/Animation]	Pictures are recorded with Time Lapse Shot or Stop Motion Animation.

Recording 4K Photos

Applicable modes:   **P** **A** **S** **M**    

The camera allows you to take burst pictures of 8 million pixels (approx.) at 30 frames/second. After taking these pictures, you can save the desired moment extracted from their burst file.



- Use a UHS Speed Class 3 card to record 4K photos. (P11)
- When recording 4K photos, the angle of view is narrower.

1 Set the drive mode dial to .

2 Select the menu. (P22)

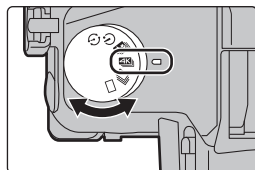
MENU →  **[Rec]** → **[4K PHOTO]** → **[Rec Method]**



 [4K Burst]*	<p>For capturing the best shot of a fast-moving subject</p> <p>Burst recording is performed while the shutter button is pressed and held.</p> <p>(A) Press and hold (B) Recording is performed</p>	
 [4K Burst(S/S)]* "S/S" is an abbreviation of "Start/Stop".	<p>For capturing unpredictable photo opportunities</p> <p>Burst recording starts when the shutter button is pressed and stops when pressed again.</p> <p>(C) Start (First) (D) Stop (Second) (E) Recording is performed</p>	
 [4K Pre-Burst]	<p>For recording as needed whenever a photo opportunity arises</p> <p>Burst recording is performed for approximately 1 second before and after the moment that the shutter button is pressed.</p> <p>(F) Approximately 1 second (G) Recording is performed</p>	

* Motion picture file will be recorded and played back in separate files in the following cases (You can continue recording without interruption.):

- When using an SDHC memory card: If the file exceeds 4 GB
- When using an SDXC memory card: If the continuous recording time exceeds 3 hours and 4 minutes or If the file exceeds 96 GB

3 Press the shutter button halfway to exit the menu.

4 Press the shutter button to perform recording.

- The camera will perform burst recording of a 4K photo and saves it as a 4K burst file in [MP4] format.
- When [Auto Review] is enabled, the picture selection screen will be displayed automatically.



- When [4K Pre-Burst] is set, the battery drains faster and the camera temperature rises. Select [4K Pre-Burst] only when recording.

Selecting pictures from 4K burst file and saving

1 Select an image with the [▲] icon on the playback screen, and press ▲.

- If the image was recorded with [4K Pre-Burst], proceed to step 3.



2 Drag the slide bar to make a rough selection of scenes.

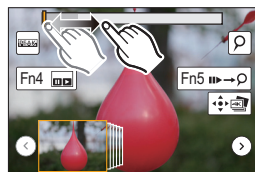

3 Drag the frames to select the frame you want to save as a picture.

4 Touch [◀▶] to save the picture.



You can save pictures taken during a 5 second period at once by using [4K PHOTO Bulk Saving] in the [Playback] menu.

- The picture will be saved in JPEG format.

Controlling Focus After Recording

(Post Focus/Focus Stacking)

Applicable modes: 

The camera allows you to take 4K burst pictures while shifting the focus to different areas. After taking these pictures, you can select the desired focus area.

This function is suited for recording still objects.

It is also possible to select multiple focus areas and create a single merged picture. (Focus Stacking)

- We recommend that you use a tripod when recording images to be used for Focus Stacking.
- Use a UHS Speed Class 3 card. (P11)
- When using [Post Focus], the angle of view is narrower.

1 Set the drive mode dial to .

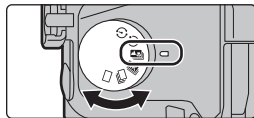

2 Decide on the composition, and press the shutter button halfway.

- Auto Focus will detect focus areas on the screen. (Excluding the edges of the screen)
- If no areas on the screen can be brought into focus, the focus display (A) will flash. Recording is not possible in this case.



3 Press the shutter button fully to start recording.

- The focus point changes automatically while recording. When the icon (B) disappears, recording automatically ends.



From the time you press the shutter button halfway until the end of recording:

- Maintain the same distance to the subject and the same composition.
- A motion picture in [MP4] format will be recorded. (Audio will not be recorded.)
- When [Auto Review] is enabled, a screen that lets you select the desired focus area will be displayed. (P31)

Selecting the desired focus area and saving a picture







- 1 Select an image with the  icon on the playback screen, and press **▲**.



- 2 Select and touch a focus area.

- If a picture that is in focus is not available for the selected area, a red frame will be displayed. You cannot save a picture in this case.
- You cannot select the edges of the screen.



Button operation	Touch operation	Description of operation
	Touching	Selects a focus area. • It cannot be selected during enlarged display.
		Enlarges the display.
		Reduces the display (during enlarged display).
[Fn4]		Switches to the Focus Stacking function. (P32)
[Fn5]		In-focus portions are highlighted with colour. ([Peaking]) • Switches in order of [OFF]→[ON] ([LOW]) → [ON] ([HIGH]).
[MENU/SET]		Saves the picture.

- You can fine-adjust the focus by dragging the slide bar during enlarged display. (You can also perform the same operation by pressing **◀/▶**.)



- 3 Touch  to save the picture.

- The picture will be saved in JPEG format.

Merging multiple pictures to widen the focus range (Focus Stacking)



- 1 Touch  in step 2 of “Selecting the desired focus area and saving a picture”.
- 2 Touch the merging method.

[Auto Merging]	Automatically selects pictures that are suited to be merged, and merges them into a single picture. <ul style="list-style-type: none"> • Priority will be given to pictures with closer focus. • Pictures will be merged into a single picture and the resulting picture will be saved when this item is selected.
[Range Merging]	Merges pictures with specified focus areas into a single picture.

- 3 (When **[Range Merging]** is selected)
Touch the desired focus area.

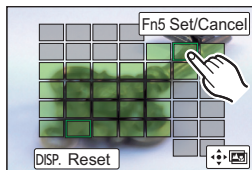
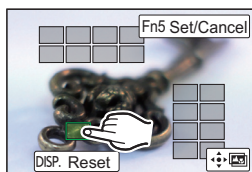
- Specify at least two areas.
- In-focus areas between the two areas will also be selected, and the combined in-focus area will be indicated.
- Grey areas indicate areas that may, if selected, cause the merged picture to look unnatural and areas that cannot be selected.
- Touch the focus area again to cancel the selection.



Button operation	Touch operation	Description of operation
	Touching	Selects an area.
[Fn5]	[Set/Cancel]	Specifies/cancels an area.
[DISP.]	[All]	Selects all areas. (Before selecting areas)
	[Reset]	Cancels all selections. (After selecting areas)
[MENU/SET]		Merges pictures and saves the resulting picture.

- 4 Touch  to merge the pictures and save the resulting picture.





- The picture will be saved in JPEG format. Recording information (Exif information) of the original picture with the closest focus distance, including the shutter speed, aperture, and ISO sensitivity, will also be recorded to the new picture.
- The camera may automatically correct the misalignments of pictures caused by camera shake. If they are corrected, the angle of view becomes slightly narrower when pictures are merged.
- Pictures may be merged into an unnatural picture in the following cases:
 - The subject moved.
 - The distance to the subject was great.
 - Pictures are too defocused (If you take pictures with a larger aperture value, the resulting picture may look less unnatural.)

Taking Pictures While Adjusting a Setting Automatically (Bracket Recording)

Applicable modes: 

You can take multiple pictures while automatically adjusting a setting by pressing the shutter button.

1 Select the menu. (P22)

[MENU] →  [Rec] → [Bracket] → [Bracket Type]	
 (Exposure Bracket)	Press the shutter button to perform recording while adjusting the exposure.
 (Aperture Bracket)*	Press the shutter button to perform recording while adjusting the aperture.
FOCUS (Focus Bracket)	Press the shutter button to perform recording while adjusting the focus position.
 (White Balance Bracket)	Press the shutter button once to take three pictures with different white balance settings automatically.

* Available in Aperture-Priority AE Mode or when the ISO sensitivity is set to [AUTO] in Manual Exposure Mode.

2 Press ▲/▼ to select [More settings] and then press [MENU/SET].

- For information on [More settings], refer to the page that describes each function.
- When [] is selected, rotate the rear dial to the right (A-B axis) or left (G-M axis) to set the range of settings.
- Press the shutter button halfway to exit the menu.

3 Focus on the subject and take a picture.

■ To deactivate Bracket

Select [OFF] in step 1.

Exposure Bracket

■ About [More settings] (step 2 in P33)

[Step]	Sets the number of pictures to be taken and the exposure compensation range. [3·1/3] (Takes three pictures with an interval of 1/3 EV) to [7·1] (Takes seven pictures with an interval of 1 EV)
[Sequence]	Sets the order in which pictures are taken.
[Single Shot Setting]*	[□]: Takes one picture each time you press the shutter button. [📷]: Takes all the pictures set to be taken when you press the shutter button once.

- * Not available for burst recording. When using burst recording, if you press and hold the shutter button, recording will be performed continuously until a specified number of pictures are taken.

Aperture Bracket

Recording Mode: **A** **M**

■ About [More settings] (step 2 in P33)

[Image Count]	[3], [5]: Takes a specified number of pictures with different aperture values within the range based on the initial aperture value. [ALL]: Takes pictures using all aperture values.
----------------------	-----------------------------------------------------------------------------------------------------------------------------------------------------------------------------------------

- When using burst recording, if you press and hold the shutter button, recording will be performed until a specified number of pictures are taken.

Focus Bracket

■ About [More settings] (step 2 in P33)

[Step]	Sets the interval between focus positions.
[Image Count]*	Sets the number of pictures to be taken.
[Sequence]	[0/-/+]: Alternately moves the focus position closer and farther away within the range centred on the initial position as you take pictures. [0/+]: Moves the focus position farther away from the initial position as you take pictures.

- * Not available for burst recording. When using burst recording, if you press and hold the shutter button, recording will be performed continuously until a specified number of pictures are taken.



Image Stabiliser

Applicable modes:        

Automatically detects and prevents jitter. For motion picture recording, the 5-Axis Hybrid Image Stabiliser function is available. It uses both the optical stabiliser of the lens and the electronic stabiliser of the camera's sensor. It corrects different types of jitters including those that occur during zoom recording and also recording while walking.

Select the menu. (P22)

MENU →  **[Rec]** → **[Stabilizer]**

[Operation Mode]	 ([Normal])	Vertical and horizontal shake are compensated for.
	 ([Panning])	Camera shake is corrected for up/down movements. This mode is ideal for panning (a method of taking pictures which involves turning the camera to track the movements of a subject which continues to move in a fixed direction).
	[OFF]	[Stabilizer] does not work.
[E-Stabilization (Video)]	Corrects jitters that occur in 5 directions during motion picture recording, namely the vertical direction, horizontal direction, rotation axis, vertical rotation, and horizontal rotation (5-axis Hybrid Image Stabiliser function). [ON]/[OFF] • If you set this item to [ON] , the angle of view of recorded motion pictures may become narrower.	

Zoom types and use

Optical Zoom

Applicable modes:        

Zooms in without deteriorating the image quality.

Maximum magnification: 20×

Extra Optical Zoom

Applicable modes:        

This function works when any of the picture sizes (P50) indicated with  is selected. You can zoom in further than you can with the Optical Zoom without deteriorating the image quality.

Maximum magnification: 40×

(This includes the optical zoom magnification. The magnification level differs depending on [Picture Size] setting.)

Intelligent Zoom

Applicable modes:   P A S M    

You can zoom in up to twice the original zoom magnification while minimising the deterioration of the image quality.

MENU →  [Rec]/  [Motion Picture] → [i.Zoom] → [ON]/[OFF]

[Digital Zoom]

Applicable modes:   P A S M    

Although the image quality deteriorates every time you zoom in further, you can zoom in up to four times the original zoom magnification.

MENU →  [Rec]/  [Motion Picture] → [Digital Zoom] → [ON]/[OFF]

Recording Motion Picture/4K Motion Picture

Applicable modes:   P A S M    

The camera can record full high definition motion pictures that comply with the AVCHD standard or 4K motion pictures in MP4 or MOV format.

Audio is recorded in stereo.

1 Start recording by pressing the motion picture button.

- (A) Elapsed recording time
- (B) Available recording time

- Recording of motion picture appropriate for each mode is possible.
- The recording state indicator (red) (C) will flash while recording motion pictures.
- Release the motion picture button right after you press it.

2 Stop the recording by pressing the motion picture button again.

- Still picture recording is also possible during the motion picture recording by fully pressing the shutter button.

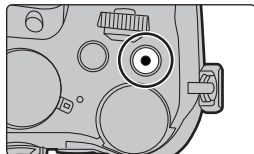

- [AVCHD]:

You can continue recording without interruption even if the file size exceeds 4 GB, but the motion picture file will be divided.

- [MP4] (with a [Rec Quality] size of [FHD] or [HD]):

You can continue recording without interruption even if the continuous recording time exceeds 30 minutes or the file size exceeds 4 GB, but the motion picture file will be divided and recorded/played back separately.

- [MP4] (with a [Rec Quality] size of [4K]), [MP4 (LPCM)], or [MOV]:

Motion picture file will be recorded and played back in separate files in the following cases (You can continue recording without interruption.):

- When using an SDHC memory card: If the file exceeds 4 GB

- When using an SDXC memory card: If the continuous recording time exceeds 3 hours and 4 minutes or If the file exceeds 96 GB

■ Setting the format, size and recording frame rate

MENU →  **[Motion Picture]** → **[Rec Format]**

[AVCHD]	This data format is suitable for when playing back on a high-definition TV, etc.
[MP4]	This data format is suitable for when playing back on a PC, etc.
[MP4 (LPCM)]	The MP4 data format for image editing.
[MOV]	Data format for image editing.

MENU →  **[Motion Picture]** → **[Rec Quality]**

When [AVCHD] is selected

(○: Available, —: Not available)

Item	System frequency			Size	Recording frame rate	Sensor output	Bit rate
	59.94Hz (NTSC)	50.00Hz (PAL)	24.00Hz (CINEMA)				
[FHD/28M/60p]*	○	—	—	1920×1080	59.94p	59.94	28 Mbps
[FHD/28M/50p]*	—	○	—	1920×1080	50.00p	50.00	28 Mbps
[FHD/17M/60i]	○	—	—	1920×1080	59.94i	59.94	17 Mbps
[FHD/17M/50i]	—	○	—	1920×1080	50.00i	50.00	17 Mbps
[FHD/24M/30p]	○	—	—	1920×1080	59.94i	29.97	24 Mbps
[FHD/24M/25p]	—	○	—	1920×1080	50.00i	25.00	24 Mbps
[FHD/24M/24p]	○	—	—	1920×1080	23.98p	23.98	24 Mbps

* AVCHD Progressive

When [MP4] is selected

(○: Available, —: Not available)

Item	System frequency			Size	Recording frame rate	Sensor output	Bit rate
	59.94Hz (NTSC)	50.00Hz (PAL)	24.00Hz (CINEMA)				
[4K/100M/30p]*	○	—	—	3840×2160	29.97p	29.97	100 Mbps
[4K/100M/25p]*	—	○	—	3840×2160	25.00p	25.00	100 Mbps
[4K/100M/24p]*	○	—	—	3840×2160	23.98p	23.98	100 Mbps
[FHD/28M/60p]	○	—	—	1920×1080	59.94p	59.94	28 Mbps
[FHD/28M/50p]	—	○	—	1920×1080	50.00p	50.00	28 Mbps
[FHD/20M/30p]	○	—	—	1920×1080	29.97p	29.97	20 Mbps
[FHD/20M/25p]	—	○	—	1920×1080	25.00p	25.00	20 Mbps
[HD/10M/30p]	○	—	—	1280×720	29.97p	29.97	10 Mbps
[HD/10M/25p]	—	○	—	1280×720	25.00p	25.00	10 Mbps

* 4K motion picture

When [MP4 (LPCM)], [MOV] is selected

(○: Available, —: Not available)

Item	System frequency			Size	Recording frame rate	Sensor output	Bit rate
	59.94Hz (NTSC)	50.00Hz (PAL)	24.00Hz (CINEMA)				
[C4K/100M/24p]*1	—	—	○	4096×2160	24.00p	24.00	100 Mbps
[4K/100M/30p]*1	○	—	—	3840×2160	29.97p	29.97	100 Mbps
[4K/100M/25p]*1	—	○	—	3840×2160	25.00p	25.00	100 Mbps
[4K/100M/24p]*1	—	—	○	3840×2160	24.00p	24.00	100 Mbps
	○	—	—	3840×2160	23.98p	23.98	100 Mbps
[FHD/ALL-I*2/ 200M/60p]	○	—	—	1920×1080	59.94p	59.94	200 Mbps
[FHD/100M/60p]	○	—	—	1920×1080	59.94p	59.94	100 Mbps
[FHD/50M/60p]	○	—	—	1920×1080	59.94p	59.94	50 Mbps
[FHD/ALL-I*2/ 200M/50p]	—	○	—	1920×1080	50.00p	50.00	200 Mbps
[FHD/100M/50p]	—	○	—	1920×1080	50.00p	50.00	100 Mbps
[FHD/50M/50p]	—	○	—	1920×1080	50.00p	50.00	50 Mbps
[FHD/ALL-I*2/ 200M/30p]	○	—	—	1920×1080	29.97p	29.97	200 Mbps
[FHD/100M/30p]	○	—	—	1920×1080	29.97p	29.97	100 Mbps
[FHD/50M/30p]	○	—	—	1920×1080	29.97p	29.97	50 Mbps

[FHD/ALL-I*2/ 200M/25p]	—	○	—	1920×1080	25.00p	25.00	200 Mbps
[FHD/100M/25p]	—	○	—	1920×1080	25.00p	25.00	100 Mbps
[FHD/50M/25p]	—	○	—	1920×1080	25.00p	25.00	50 Mbps
[FHD/ALL-I*2/ 200M/24p]	—	—	○	1920×1080	24.00p	24.00	200 Mbps
	○	—	—	1920×1080	23.98p	23.98	200 Mbps
[FHD/100M/24p]	—	—	○	1920×1080	24.00p	24.00	100 Mbps
	○	—	—	1920×1080	23.98p	23.98	100 Mbps
[FHD/50M/24p]	—	—	○	1920×1080	24.00p	24.00	50 Mbps
	○	—	—	1920×1080	23.98p	23.98	50 Mbps

*1 4K motion picture

*2 ALL-Intra:

"ALL-Intra" refers to a data compression method in which each frame is compressed. The file size of motion pictures recorded in this method becomes larger, but this method can prevent the loss of image quality because editing does not require re-encoding.

- When recording motion pictures in 4K, use a card rated as UHS Speed Class 3. (P11)
- The angle of view of motion pictures in 4K is narrower than those of motion pictures in other sizes.
- To ensure highly accurate focus, 4K photos are recorded at reduced Auto Focus speeds. It may be difficult to focus on the subject with Auto Focus, but this is not a malfunction.

Recording Motion Pictures Using Various Effects and Advanced Settings (Creative Video Mode)

Recording Mode: 

[Slow/Quick] (P40)	It is possible to switch to slow or quick motion during motion picture recording.
[Dolly Zoom] (P40)	Allows you to record images that only change the angle of view in the background while keeping the size of the subject (person) constant. The images are played back with a quick motion effect of ×2.
[4K Live Cropping] (P41)	It is possible to record a motion picture that pans and zooms in/out while leaving the camera in a fixed position by cropping the motion picture down from the 4K angle of view to Full High Definition.
[Exposure Mode] (P43)	It is possible to manually change the aperture and shutter speed and record motion pictures.
[Variable Frame Rate] (P43)	You can record slow motion or quick motion pictures by changing the frame rate. In [Variable Frame Rate], you can set the frame rate for recording.

■ Note on recording with the [Slow/Quick], [Dolly Zoom] or [Variable Frame Rate] function

- You can use the [Rec Format] and [Rec Quality] settings below.

[Rec Format]	[System Frequency]	[Rec Quality]
[AVCHD]	[59.94 Hz (NTSC)]	[FHD/24M/30p]/[FHD/24M/24p]
	[50.00 Hz (PAL)]	[FHD/24M/25p]
	[24.00 Hz (CINEMA)]	—
[MP4]	—	—
[MP4 (LPCM)]/[MOV]	[59.94 Hz (NTSC)]	[FHD/100M/30p]/[FHD/100M/24p]
	[50.00 Hz (PAL)]	[FHD/100M/25p]
	[24.00 Hz (CINEMA)]	[FHD/100M/24p]

Changing the frame rate while recording a motion picture ([Slow/Quick])

- Set the mode dial to [M].
- Select an item that supports [Variable Frame Rate]. (P40)

MENU →  [Motion Picture] → [Rec Format]

- [MP4] does not support [Variable Frame Rate].

MENU →  [Motion Picture] → [Rec Quality]

- Items available for recording with a [Variable Frame Rate] are indicated as [VFR available] on the screen.

- Select the menu. (P22)

MENU →  [Motion Picture] → [Slow/Quick] → [ON]

- Press the motion picture button (or shutter button) to start recording.
 - Press and hold [Fn1] to record the scene that you want to record in quick motion, or press and hold [Fn2] to record the scene that you want to record in slow motion.
- Audio will not be recorded during quick or slow motion recording.

Recording motion pictures in which only their angle of view in the background changes continuously ([Dolly Zoom])

- Set the mode dial to [M].
- Select an item that supports [Variable Frame Rate]. (P40)

MENU →  [Motion Picture] → [Rec Format]

- [MP4] does not support [Variable Frame Rate].

MENU →  [Motion Picture] → [Rec Quality]

- Items available for recording with a [Variable Frame Rate] are indicated as [VFR available] on the screen.

3 Select the menu. (P22)

MENU →  [Motion Picture] → [Dolly Zoom] → [ON]

4 Align the subject's position with the centre frame.

- The Auto Focus Mode will be set to Face/Eye Detection.
- Adjust so that the face detection frame and centre frame appear in the same size. When they appear in the same size, the colour of the centre frame changes from red to green.

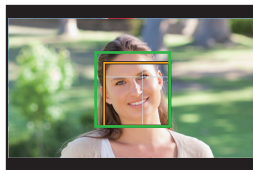

5 Press the motion picture button (or shutter button) to start recording.

6 Press [Fn1] or [Fn2].

7 Adjust the position of the camera so that the subject stays the same size.

- Move the recording position forward or backward to adjust it.
- Zoom in/out while adjusting the camera's position to achieve a dolly zoom effect.
- When recording motion picture, move the camera away from the subject if you have pressed [Fn1], or move the camera closer to the subject if you have pressed [Fn2].
- Adjust the position of the camera so that the subject fits in the centre frame.
- Audio is not recorded.

Recording Motion Pictures that Pan and Zoom While Maintaining a Fixed Camera Position ([4K Live Cropping])

- Hold the camera firmly in place while recording.
- Recording will be performed with a motion picture size of [FHD].

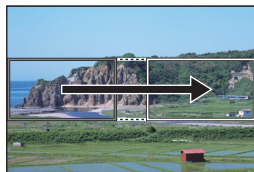

Pan

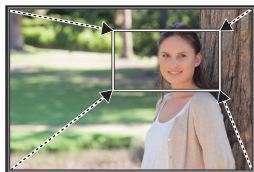

Zoom in

- When you want to zoom in/out, set different angles of view for the cropping start and end frames. For example, to zoom in, set a larger angle of view for the start frame and a smaller angle of view for the end frame.

1 Set the mode dial to [M].

2 Select the menu. (P22)

MENU →  [Motion Picture] → [4K Live Cropping] → [40SEC]/[20SEC]

- The angle of view narrows.

3 Set the cropping start frame.

Ⓐ Cropping start frame

- When making settings for the first time, a cropping start frame of size 1920×1080 is displayed. (After setting the cropping start frame and end frame, the start frame and end frame that you set immediately before will be displayed.)
- The camera will remember the frame position and size even when the camera is turned off.

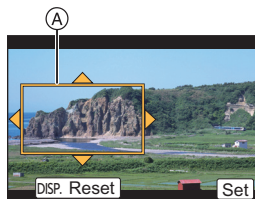

Button operation	Touch operation	Description of operation
▲/▼/◀/▶	Touching	Moves the frame
	Pinch out/ Pinch in	Enlarges/reduces the frame (The range of settings allowed is from 1920×1080 to 3840×2160.)
[DISP.]	[Reset]	Returns the position of the frame to the centre and its size to the default setting.
[MENU/SET]	[Set]	Decides the position and size of the frame

4 Repeat step 3, and then set the cropping end frame.

Ⓑ Cropping end frame

- The setting of the Auto Focus Mode switches to [AF-ON].
(The eye to be in focus is not indicated.)

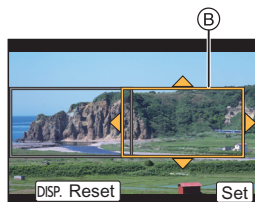

5 Press the motion picture button (or shutter button) to start recording.

- Immediately release the motion picture button (or the shutter button) after pressing it.
- When the set operating time has elapsed, recording automatically ends.
To end recording midway, press the motion picture button (or the shutter button) again.

■ Changing the position and size of a crop frame

Press [Fn6] while the recording screen is displayed, and perform steps 3 and 4.

■ To cancel [4K Live Cropping] recording

Set [OFF] in step 2.

- The following [Rec Format] and [Rec Quality] settings cannot be used:
 - A [Rec Format] setting of [AVCHD]
 - [Rec Quality] settings with a size of [4K] or [C4K]
 - [Rec Quality] settings with a frame rate of [60p] or [50p]

Recording motion pictures with manually set aperture value/shutter speed/ISO sensitivity ([Exposure Mode])

- 1 Set the mode dial to **[M]**.
- 2 Select the menu. (P22)

MENU →  **[Motion Picture]** → **[Exposure Mode]** → **[P]/[A]/[S]/[M]**

- The operation for changing the aperture value, shutter speed or ISO sensitivity is the same as the operation for setting the mode dial to **P**, **A**, **S** or **M**.

- 3 Press the motion picture button (or shutter button) to start recording.
 - When [Exposure Mode] is set to [M], [AUTO] of the ISO sensitivity will switch to [125].
- 4 Stop the recording by pressing the motion picture button (or shutter button) again.

Recording in Slow or Quick motion ([Variable Frame Rate])

Slow motion pictures

Set a frame rate that provides more frames than the recording frame rate in [Rec Quality] does.

Example: If you set [FHD/100M/24p] to [48fps] and record a motion picture, a slow motion effect of 1/2 can be gained.

Quick motion pictures

Set a frame rate that provides less frames than the recording frame rate in [Rec Quality] does.

Example: If you set [FHD/100M/24p] to [12fps] and record a motion picture, a quick motion effect of 2× can be gained.

- 1 Set the mode dial to **[M]**.
- 2 Select an item that supports [Variable Frame Rate]. (P40)

MENU →  **[Motion Picture]** → **[Rec Format]**

- [MP4] does not support [Variable Frame Rate].

MENU →  **[Motion Picture]** → **[Rec Quality]**

- Items available for recording with a [Variable Frame Rate] are indicated as [VFR available] on the screen.

- 3 Select the menu. (P22)

MENU →  **[Motion Picture]** → **[Variable Frame Rate]** → **[ON]**

- 4 Press ◀/▶ to select the frame rate you will record the item with.**
- You can select a value between [2fps] and [120fps].
- 5 Press [MENU/SET].**
- Exit the menu after it is set.

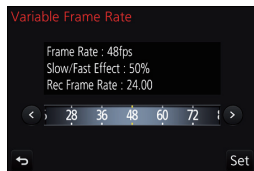

Minimising operational sounds during motion picture recording

The operational sound of the zoom or button operation may be recorded when it is operated during the recording of a motion picture.

Using touch icons allows silent operation while recording motion pictures.

- Start recording.**
- Touch [📷].**
- Touch icon.**

	Zoom		Exposure Compensation
	Aperture value		ISO sensitivity (GAIN:Gain (dB))
	Shutter speed		Mic level adjustment

- 4 Drag the slide bar to set.**
- The speed of the operation varies depending on the position you touch.

	Changes the setting slowly
	Changes the setting quickly

- 5 Stop recording.**

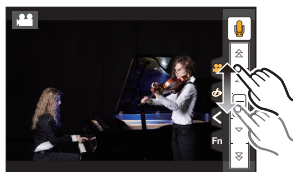

Playing Back Pictures

1 Press [▶].

2 Press ◀/▶.

◀: Play back the previous picture

▶: Play back the next picture

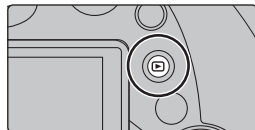

- The playback screen appears if the camera is turned on while pressing [▶].
- When the camera is switched to the playback screen from the recording screen, the lens barrel is retracted after approx. 15 seconds.



Sending an image to a web service

If you press ▼ when displaying images one by one, you can easily send an image to a web service.

- For details, refer to the “Operating Instructions for advanced features (PDF format)”.

Playing Back Motion Pictures

This unit was designed to play motion pictures using the AVCHD, MP4 and MOV formats.

- Motion pictures are displayed with the motion picture icon (👤👤).

Press ▲ to play back.

- Ⓐ Motion picture recording time

■ Operations during Motion Picture Playback

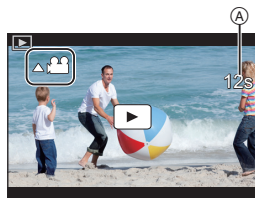

Button operation	Touch operation	Description of operation
▲	▶/	Play/Pause
▼	■	Stop
◀	◀◀	Fast rewind*1
	◀	Frame-by-frame rewind*2 (while pausing)
▶	▶▶	Fast forward*1
	▶	Frame-by-frame forward (while pausing)
	−	Reduce volume level
	+	Increase volume level



*1 The fast forward/rewind speed increases if you press ▶/◀ again.

*2 When a motion picture recorded with [AVCHD] is rewound frame-by-frame, its frames will be shown in intervals of approximately 0.5 seconds.

Deleting Pictures

Once deleted, pictures cannot be recovered.

■ To delete a single picture

- 1 In Playback Mode, select the picture to delete and then press [].**
 - The same operation can be performed by touching [].

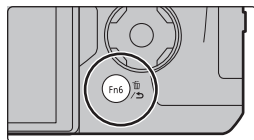

- 2 Press ▲ to select [Delete Single] and then press [MENU/SET].**

■ To delete multiple pictures or all the pictures

- 1 In Playback Mode, press [].**
- 2 Press ▲/▼ to select the picture deletion method, and then press [MENU/SET].**

[Delete Multi]	Up to 100 pictures can be selected at once. • Group pictures are treated as a single picture. All pictures in a group will be deleted.
[Delete All]	It is possible to delete all pictures except the ones set as favourite when [All Delete Except Favorite] is selected.

- 3 (When [Delete Multi] is selected)
Press ▲/▼/◀/▶ to select the picture, and then press [MENU/SET] to set. (Repeat this step.)**

-  appears on the selected pictures.
If [MENU/SET] is pressed again, the setting is cancelled.



- 4 (When [Delete Multi] is selected)
Press ◀ to select [OK], and then press [MENU/SET] to execute.**

Menu list



To display explanations of the menu items.

When [Menu Information] in the [Setup] menu is set to [ON], explanations of the menu items and settings are displayed on the menu screen.

Ⓐ Explanations of the menu



- [Photo Style], [Filter Settings], [AFS/AFF], [Metering Mode], [Highlight Shadow], [i.Dynamic], [i.Resolution], [Diffraction Compensation], [i.Zoom], [Digital Zoom] and [Stabilizer] are common to both the [Rec] menu and [Motion Picture] menu. Changing these settings in one of these menus is reflected in other menu.

[Rec]

This menu lets you set the aspect ratio, number of pixels, 4K Photo and other aspects of the pictures you are recording.

[Photo Style]	[Highlight Shadow]	[ISO Increments]
[Filter Settings]	[i.Dynamic]	[Extended ISO]
[Aspect Ratio]	[i.Resolution]	[Long Shtr NR]
[Picture Size]	[iHandheld Night Shot]	[Diffraction Compensation]
[Quality]	[iHDR]	[i.Zoom]
[AFS/AFF]	[HDR]	[Digital Zoom]
[Metering Mode]	[Multi Exp.]	[Color Space]
[Burst Rate]	[Panorama Settings]	[Stabilizer]
[4K PHOTO]	[Shutter Type]	[Face Recog.]
[Bracket]	[Flash]	[Profile Setup]
[Self Timer]	[Red-Eye Removal]	
[Time Lapse/Animation]	[ISO Limit Set]	

[Motion Picture]

This menu lets you set the [Rec Format], [Rec Quality], and other aspects for motion picture recording.

[Photo Style]	[Metering Mode]	[Sound Output]
[Filter Settings]	[Highlight Shadow]	[Silent Operation]
[Slow/Quick]	[i.Dynamic]	[Mic Level Disp.]
[Dolly Zoom]	[i.Resolution]	[Mic Level Adj.]
[4K Live Cropping]	[Diffraction Compensation]	[Special Mic.]
[Snap Movie]	[Master Pedestal Level]	[Noise Reduction for Ext. Mic]
[Rec Format]	[Luminance Level]	[Mic Level Limiter]
[Rec Quality]	[Synchro Scan]	[Wind Noise Canceller]
[Exposure Mode]	[i.Zoom]	[Wind Cut]
[Variable Frame Rate]	[Digital Zoom]	[Zoom Mic]
[AFS/AFF]	[Stabilizer]	[SS/Gain Operation]
[Picture Mode]	[Time Code]	[Color Bars]
[Continuous AF]	[HDMI Rec Output]	
[Level Shot]	[Flkr Decrease]	

[Custom]

Operation of the unit, such as displaying of the screen and button operations, can be set up according to your preferences.

[Cust.Set Mem.]	[MF Guide]	[Fn Button Set]
[Silent Mode]	[Peaking]	[Zoom Lever]
[AF/AE Lock]	[Histogram]	[Zoom Ring]
[AF/AE Lock Hold]	[Guide Line]	[Slow Zoom Button Setting]
[Shutter AF]	[Center Marker]	[Slow Zoom Speed]
[Half Press Release]	[Highlight]	[Soft Zoom]
[Quick AF]	[Zebra Pattern]	[Lens Position Resume]
[Eye Sensor AF]	[Monochrome Live View]	[Lens Retraction]
[Pinpoint AF Time]	[Constant Preview]	[Q.MENU]
[Pinpoint AF Display]	[Expo.Meter]	[Dial Set.]
[AF Assist Lamp]	[LVF Disp.Style]	[Video Button]
[Direct Focus Area]	[Monitor Disp. Style]	[Eye Sensor]
[Focus/Release Priority]	[Monitor Info. Disp.]	[Touch Settings]
[AF Sensitivity]	[Rec Area]	[Touch Scroll]
[AF+MF]	[Video-Priority Display]	[Menu Guide]
[MF Assist]	[Auto Review]	
[MF Assist Display]		

[Setup]

This menu lets you perform the clock settings, select the operating beep tone settings and set other settings which make it easier for you to operate the camera.

You can also configure the settings of Wi-Fi related functions.

[Online Manual]	[Monitor Luminance]	[Exposure Comp. Reset]
[Clock Set]	[Economy]	[No.Reset]
[World Time]	[USB Mode]	[Reset]
[Travel Date]	[TV Connection]	[Reset Wi-Fi Settings]
[Wi-Fi]	[Menu Resume]	[System Frequency]
[Beep]*	[Menu Background]	[Level Gauge Adjust.]
[Headphone Volume]	[Menu Information]	[Activate]
[Live View Mode]	[Language]	[Demo Mode]
[Monitor Display]/ [Viewfinder]	[Version Disp.]	[Format]

* This allows you to set the volume for electronic sound and the electronic shutter sound.

[Playback]

This menu lets you set the Protection, Cropping or Print Settings, etc. of recorded pictures.

[Slide Show]	[Text Stamp]	[Favorite]
[Playback Mode]	[Video Divide]	[Print Set]
[Location Logging]	[Time Lapse Video]	[Protect]
[RAW Processing]	[Stop Motion Video]	[Face Rec Edit]
[4K PHOTO Bulk Saving]	[Resize]	[Picture Sort]
[Light Composition]	[Cropping]	[Delete Confirmation]
[Clear Retouch]	[Rotate]	
[Title Edit]	[Rotate Disp.]	

[Aspect Ratio]

Applicable modes:   **P** **A** **S** **M**    

This allows you to select the aspect ratio of the pictures to suit printing or the playback method.

MENU →  **[Rec]** → **[Aspect Ratio]**

[4:3]	[Aspect Ratio] of a 4:3 TV
[3:2]	[Aspect Ratio] of a 35 mm film camera
[16:9]	[Aspect Ratio] of a high-definition TV, etc.
[1:1]	Square aspect ratio

[Picture Size]

Applicable modes:   **P** **A** **S** **M**   

Set the number of pixels.

The higher the numbers of pixels, the finer the detail of the pictures will appear even when they are printed onto large sheets.

MENU →  **[Rec]** → **[Picture Size]**

When the aspect ratio is [4:3].

Settings	Image size
[L] (17.5M)	4864×3648
[EXM] (9M)	3456×2592
[EXS] (4.5M)	2432×1824

When the aspect ratio is [3:2].

Settings	Image size
[L] (20M)	5472×3648
[EXM] (10M)	3888×2592
[EXS] (5M)	2736×1824

When the aspect ratio is [16:9].

Settings	Image size
[L] (17M)	5472×3080
[EXM] (8M)	3840×2160
[EXS] (2M)	1920×1080

When the aspect ratio is [1:1].





Settings	Image size
[L] (13.5M)	3648×3648
[EXM] (6.5M)	2592×2592
[EXS] (3.5M)	1824×1824

[Quality]

Applicable modes:   **P** **A** **S** **M**   

Set the compression rate at which the pictures are to be stored.

MENU →  **[Rec]** → **[Quality]**

Settings	File format	Description of settings
	JPEG	A JPEG image in which image quality was given priority.
		A standard image quality JPEG image. This is useful for increasing the number of shots without changing the number of pixels.
[RAW_{iii}]	RAW+JPEG	You can record a RAW image and a JPEG image ( or ) simultaneously.
[RAW_{ii}]		
[RAW]	RAW	You can only record RAW images.

- RAW images are always recorded in the [3:2] (5472×3648) aspect ratio.
- When you delete an image recorded with **[RAW_{iii}]** or **[RAW_{ii}]**, both the RAW and JPEG images will be deleted simultaneously.
- When you play back an image recorded with **[RAW]**, grey areas corresponding to the aspect ratio at the time of recording are displayed.
- You can process RAW images in [RAW Processing] in the [Playback] menu.

- Use software ("SILKYPIX Developer Studio" (P57) by Ichikawa Soft Laboratory) to process and edit RAW files on a PC.

[System Frequency]

Applicable modes:   **P** **A** **S** **M**    

You can change the system frequency of the motion pictures you record and play back.

MENU →  **[Setup]** → **[System Frequency]**

[59.94 Hz (NTSC)]	For regions where the TV broadcasting system is NTSC
[50.00 Hz (PAL)]	For regions where the TV broadcasting system is PAL
[24.00 Hz (CINEMA)]	This system frequency is for creating films

- After changing the setting, turn the camera off and on.
- By default, the system frequency is set to the broadcasting system of your purchase region, [59.94 Hz (NTSC)] or [50.00 Hz (PAL)].
- **When [System Frequency] is set to a broadcasting system different from that of your region, images may not be played back correctly on the TV.**
- **If you are not familiar with broadcasting systems or will not be creating any motion pictures for films, we recommend that you use the default setting.**
- If you changed the setting but are not sure about the system frequency for the broadcasting system of your region, perform [Reset] in the [Setup] menu.

■ Once you change the system frequency

After changing the [System Frequency] setting, motion pictures may not be recorded or played back if you continue to use the card that was inserted in the camera. We recommend that you replace the card with another one and format (P16) it on the camera.

- If you continue to use the card that was inserted in the camera before you changed the setting, the camera will operate as follows:

[Rec Format]	[Rec]	[Playback]
[AVCHD]	Recording is not possible	• Motion pictures recorded with a different [System Frequency] setting cannot be played back.
[MP4]/[MP4 (LPCM)]/[MOV]	Recording is possible	

What you can do with the Wi-Fi® function

- The camera cannot be used to connect to a public wireless LAN connection.

Controlling with a Smartphone/Tablet (P53)

- Recording with a smartphone (P55)
- Playing back pictures in the camera (P55)
- Saving images stored in the camera (P56)
- Sending images to an SNS (P56)
- Writing location information on images stored in the camera (P56)
- Combining motion pictures recorded with Snap Movie according to your preference on a smartphone

Displaying pictures on a TV

Printing Wirelessly

When sending images to AV device

When sending images to PC

Using Web services

These operating instructions refer to both smartphones and tablets as “smartphones” from this point on unless noted otherwise.

- For details, refer to the “Operating Instructions for advanced features (PDF format)”.

■ About the Wi-Fi connection lamp

Lit blue: When the Wi-Fi function is ON or connected by Wi-Fi

Blinking blue: When sending picture data

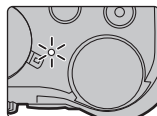

■ About the [Wi-Fi] button

In these operating instructions, a function button to which [Wi-Fi] is assigned is referred to as the [Wi-Fi] button. (By default, [Wi-Fi] is assigned to [Fn8] when the camera is in Recording Mode, while it is assigned to [Fn4] when the camera is in Playback Mode.)

- For information about the function button, refer to P23



Steps for pressing [Wi-Fi]

- 1 Touch [Fn].
- 2 Touch [Fn8].

Controlling with a Smartphone/Tablet

Installing the smartphone/tablet app “Image App”

The “Panasonic Image App” (hereafter “Image App”) is an application provided by Panasonic.

• OS

App for Android™: Android 4.0 or higher

App for iOS: iOS 7.0 or higher

1 Connect the smartphone to a network.

2 (Android) Select “Google Play™ Store”.

(iOS) Select “App Store”.

3 Enter “Panasonic Image App” or “LUMIX” into the search box.

4 Select “Panasonic Image App”  and install it.

- Use the latest version.
- Supported OSs are current as of September 2016 and are subject to change.
- Read the [Help] in the “Image App” menu for further details on how to operate.
- When you operate the “Image App” on the smartphone that is connected to the camera via Wi-Fi, [Help] in the “Image App” may not be displayed depending on the smartphone. In this case, after terminating the connection to the camera, reconnect the smartphone to a mobile phone network such as the 3G or LTE network or to a Wi-Fi router, and then display [Help] in the “Image App”.
- Some of the screens and information provided in these operating instructions may differ from your device depending on the supported OS and “Image App” version.
- The service may not be able to be used properly depending on the type of smartphone being used.

For information on the “Image App”, refer to the support site below.

<http://panasonic.jp/support/global/cs/dsc/>

(This Site is English only.)

- When downloading the app on a mobile network, high packet communication fees may be incurred depending on the details of your contract.

Connecting to a smartphone/tablet

Connecting without using the password

You can easily set up a direct connection to your smartphone without entering a password.

On the camera

Select the menu. (P22)

MENU →  **[Setup]** → **[Wi-Fi]** →
[Wi-Fi Function] → **[New Connection]** →
[Remote Shooting & View]

(A) SSID

- When the camera is ready to be connected to the smartphone, the SSID is displayed.
- You can also display the information by pressing [Wi-Fi] on the camera.

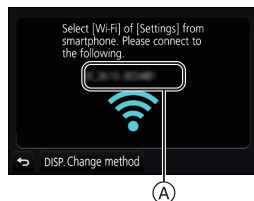

On your smartphone

- 1 Turn on the Wi-Fi function in the setting menu.
- 2 On the Wi-Fi setting screen, select the SSID displayed on the camera.
- 3 Start “Image App”.
 - When the connection confirmation screen is displayed on the camera, select [Yes] to connect. (For first time connection only)



At the time of purchase, [Wi-Fi Password] is set to [OFF].

Before connecting to a Wi-Fi network, ensure that the device displayed on the connection confirmation screen is the one you actually want to connect to. When a wrong device is displayed, if you select [Yes], the camera will automatically connect to that device.

We recommend that you set [Wi-Fi Password] to [ON] if, for example, there is another Wi-Fi device nearby.

Terminating the connection

- 1 Set the camera to Recording Mode.
- 2 Select the camera's menu items to terminate the Wi-Fi connection.

MENU →  [Setup] → [Wi-Fi] → [Wi-Fi Function] → [Yes]

• You can also terminate the connection by pressing [Wi-Fi] on the camera.

- 3 On the smartphone, close "Image App".

(If you are using an iOS device)

On the screen of "Image App", press the home button to close the app.

(If you are using an Android device)

On the screen of "Image App", press the return button twice to close the app.

Taking images via a smartphone/tablet (remote recording)

- 1 Connect to a smartphone. (P54)
- 2 Operate the smartphone.
 - 1 Select [].
 - 2 Record an image.
 - The recorded images are saved in the camera.
 - Some settings are not available.



Playing back images in the camera

- 1 Connect to a smartphone. (P54)
- 2 Operate the smartphone.
 - 1 Select [].
 - 2 Touch the image to enlarge it.



Saving images stored in the camera

- 1 **Connect to a smartphone. (P54)**
- 2 **Operate the smartphone.**



- 1 Select [].
- 2 Touch and hold an image, and drag it to save it.
 - You cannot save pictures in RAW format, motion pictures in [AVCHD], [MP4] (only those recorded with their size set to [4K] in [Rec Quality]), [MP4(LPCM)] or [MOV] format, 4K burst files, and images recorded with the [Post Focus].

Sending images in the camera to an SNS

- 1 **Connect to a smartphone. (P54)**
- 2 **Operate the smartphone.**



- 1 Select [].
- 2 Touch and hold an image, and drag it to send it to an SNS, etc.
 - The image is sent to a web service such as an SNS.

Adding location information to images stored in the camera from a smartphone/tablet

You can send location information acquired with a smartphone to the camera. **After sending the information, you can also write it on images stored in the camera.**

- 1 Start recording location information
- 2 Start recording images
- 3 Finish recording the location information
- 4 Sending and writing location information

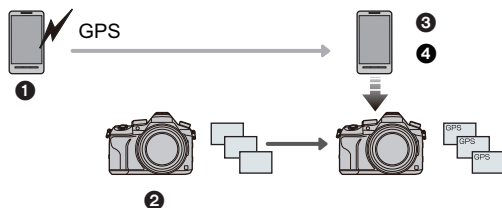

■ Operate the smartphone

- 1 **Connect to a smartphone. (P54)**
- 2 **Select [].**
- 3 **Select [Geotagging].**
- 4 **Select an icon.**



	<p>Start/stop recording location information.</p> <ul style="list-style-type: none"> • The smartphone battery drains faster while location information is being recorded. When recording of location information is not necessary, stop it.
	<p>Sending and writing location information.</p> <ul style="list-style-type: none"> • Follow the on-screen messages to operate the smartphone. • Images with location information are indicated with [GPS].

Downloading software

Download and install software to edit and play back images with a PC.

- To download the software, you need to connect the PC to the Internet.
- It may take some time to download the software depending on the communication environment.

PHOTOfunSTUDIO 9.9 XE (Windows 7/Windows 8/Windows 8.1/Windows 10)

This software allows you to manage images. For example, you can send pictures and motion pictures to a PC and sort them by recording date or model name. You can also perform operations such as writing images to a DVD, processing and correcting images, and editing motion pictures.

Check the site below to download and install the software.

Download the software while it is available for download.

http://panasonic.jp/support/global/cs/soft/download/d_pfs99xe.html

(This Site is English only.)

- Download expiration: November 2021
- For details about information such as the operating environment or operating method, refer to the "Operating Instructions for advanced features (PDF format)" or the operating instructions for the respective software programmes.
- "PHOTOfunSTUDIO" is not compatible with Mac.

SILKYPIX Developer Studio SE (Windows 7/Windows 8/Windows 8.1/Windows 10, Mac OS X v10.6 to v10.11)

This is software to edit RAW format images.

Edited images can be saved in a format (JPEG, TIFF, etc.) that can be displayed on a personal computer.

Check the site below to download and install the software.

<http://www.isl.co.jp/SILKYPIX/english/p/>

- For details on how to use the SILKYPIX Developer Studio, refer to the "Help" or the Ichikawa Soft Laboratory's support website.

LoiLoScope 30 day full trial version (Windows 7/Windows 8/Windows 8.1/Windows 10)

This software allows you to edit motion pictures with ease.

Check the site below to download and install the software.

<http://loilo.tv/product/20>

- Only the trial version will be installed.
- For more information on how to use LoiLoScope, read the LoiLoScope manual available for download at the site.
- "LoiLoScope" is not compatible with Mac.

Monitor Display/Viewfinder Display

- The following images are examples of when the display screen is set to [] (monitor style) in the monitor.

In recording

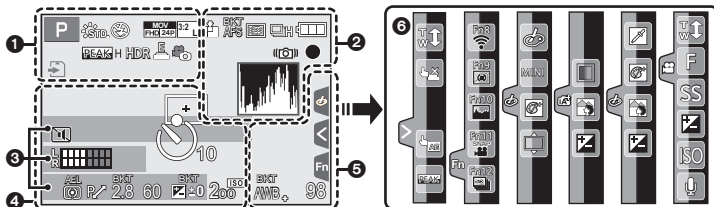

1

	Recording Mode (P19)
C 1	Custom settings
	Photo Style
	Flash Mode
	Flash
	Recording format/Recording quality (P37)
	Snap Movie
	Recording format/Recording quality*1 (P37)/Variable Frame Rate*1 (P43)
	Picture size/Aspect Ratio (P50)
	Image size (Panorama Shot Mode)
	Image effect (filter) adjustment display
EXPS	Image effect (filter) setting

	Card (displayed only during recording)
	HDMI Recording Control
8m30s	Elapsed recording time*2 (P36)
	Simultaneous recording indicator
	Automatic viewfinder/monitor switching (P17)
	Peaking
	Highlight Shadow
HDR	HDR/iHDR
	Multi exposure
E	Electronic shutter
100%	Variable Frame Rate (P43)
	Picture Mode (Photo Priority)
	Slow/Quick (P40)
	Dolly Zoom (P40)

2	RAW	Quality (P50)	4		AF area
	AFS AFF AFC MF	Focus Mode		+	Spot metering target
	BKT AFS	Focus Bracket (P34)		+	Centre marker display
		Post Focus (P30)			Self-timer
		AF Mode			Zoom Microphone
		Pull Focus			Mic level display
		Face Recognition			External Microphone
	AFL	AF Lock			ND filter (P21)
		Burst			ND filter (P21)
		4K Photo (P28)		ND AUTO / ND 4 / ND 16 / ND 64 / ND OFF	ND filter (P21)
		Self-timer			Silent Mode
		Battery indication			Mic Level Limiter (OFF)
		Image Stabiliser (P35)		TC 00:00:00:00	Time Code
		Jitter alert		AEL	AE Lock
		Recording state (Flashes red.)/ Focus (Lights green.) (P18)			Metering Mode
		Focus (Under low illumination)			Programme Shift
		Focus (Starlight AF)		2.8	Aperture value (P18)
		Connected to Wi-Fi			Aperture Bracket (P34)
		Histogram		60	Shutter speed (P18)
3					Exposure compensation value
	Name* ³				Exposure Bracket (P34)
	Number of days that have passed since the departure date* ⁴				Brightness (P25)
	Age* ³				Manual Exposure Assistance
	Location* ⁴			200	ISO sensitivity
	Current date and time/Travel destination setting* ⁴ :			0dB	Gain (dB)
		Exposure meter	5		
		Zoom			White Balance Bracket
					White Balance Fine Adjustment
					White Balance
					Colour (P25)
				98	Number of recordable pictures
				r20	Maximum number of pictures that can be taken continuously
				R8m30s	Available recording time* ²

6

Touch tab

		Touch zoom
		Touch Shutter
		Touch AE
		Peaking
		Function button (P23)
		Colour (P25)
		Defocus control function (P25)
		Brightness (P25)
		Type of defocus ([Miniature Effect])
		One point colour
		Position of the light source
		Image effect (filter) adjustment
		Image effect ON/OFF
		Image effect (filter)
		Aperture value (P18)
		Shutter speed (P18)
		ISO sensitivity
		Gain (dB)
		Microphone level adjustment

*1 This is displayed only when [Video-Priority Display] in the [Custom] menu is set to [ON].

*2 h: hour, m: minute, s: second

*3 This is displayed for about 5 seconds when the camera is turned on if the [Profile Setup] setting is set.

*4 This is displayed for about 5 seconds when the camera is turned on, after setting the clock and after switching from Playback Mode to Recording Mode.

In recording

On-monitor recording information

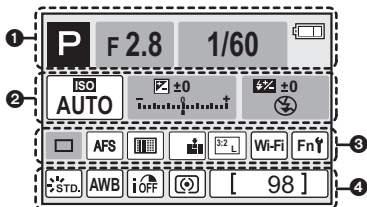

1

	Recording Mode (P19)
	Aperture value (P18)
	Shutter speed (P18)
	Battery indication

2

	ISO sensitivity
	Gain (dB)
	Exposure compensation value
	Brightness (P25)
	Manual Exposure Assistance
	Flash Mode
	Flash

3

	Single
	Burst
	4K Photo
	Self-timer
	Focus Mode
	AF Mode
	RAW
	Picture size/Aspect Ratio (P50)
	Wi-Fi (P52)
	Function button setting (P23)

4

	Photo Style
	White Balance
	Intelligent Dynamic Range Control
	Metering Mode
	Number of recordable pictures
	Maximum number of pictures that can be taken continuously
	Available recording time

Troubleshooting

First, try out the following procedures.



If the problem is not resolved, it may be improved by selecting [Reset] on the [Setup] menu.

- Please also refer to the “Operating Instructions for advanced features (PDF format)”, which describes more detailed information.

**The camera cannot be operated even when it is turned on.
The camera turns off immediately after it is turned on.**

- The battery is exhausted.
→ Charge the battery. (P14)

The battery becomes flat too quickly.

- When [] ([4K Pre-Burst]) is selected, the battery drains faster.
→ Select [] ([4K Pre-Burst]) only when recording.

The subject is not focused properly.

- The subject is beyond the focus range of the camera.
- Is [Focus/Release Priority] in the [Custom] menu set to [RELEASE]?
- Is [Shutter AF] in the [Custom] menu set to [OFF]?
- Is the AF Lock applied incorrectly?

**The recorded picture is blurred.
The Image Stabiliser is not effective.**

- The shutter speed will become slower and the Image Stabiliser function may not work properly when taking pictures especially in dark places.
→ We recommend using a tripod and the self-timer when taking pictures with a slow shutter speed.

The subject appears distorted on the picture.

- If you record a moving subject when using the electronic shutter or recording motion picture or a 4K photo, the subject may appear distorted on the picture. This is characteristic of MOS sensors which serve as the camera's pickup sensors. This is not a malfunction.

Striping or flicker may appear under lighting such as fluorescent lighting and LED lighting fixture.

- This is characteristic of MOS sensors which serve as the camera's pickup sensors. This is not a malfunction.
- Are you taking pictures with the electronic shutter?
→ When using the electronic shutter, lowering the shutter speed may reduce the effect of the horizontal stripes.
- If noticeable flicker or striping is seen under lighting such as a fluorescent or LED lighting fixture when recording motion pictures, you can reduce the flicker or striping by setting up [Flkr Decrease] and fixing the shutter speed. It is possible to select a shutter speed from [1/50], [1/60], [1/100], or [1/120]. You can set the shutter speed manually in the Creative Video Mode. (P20)

The brightness or the hue of the recorded picture is different from the actual scene.

- When recording under fluorescent or LED lighting fixture, etc., increasing the shutter speed may introduce slight changes to brightness and colour. These are a result of the characteristics of the light source and do not indicate a malfunction.
- When recording subjects in extremely bright locations or recording under fluorescent lighting, LED lighting fixture, mercury lamp, sodium lighting, etc., the colours and screen brightness may change or horizontal striping may appear on the screen.

Recording motion pictures is not possible.

- If you continue to use the same card after changing [System Frequency] (P51), motion pictures may not be recorded. To record with the same card, reset [System Frequency] to the original setting. To record motion pictures with the current setting, try the following:
 - Perform formatting (P16) on this unit after saving necessary data on a PC, etc.
 - Insert a different card.
- You may not be able to record for a short while after turning this unit on when using a large capacity card.

Sometimes it is difficult to focus with Auto Focus when recording 4K motion pictures.

- This phenomenon occurs when the camera is trying to record with highly accurate focus at a reduced Auto Focus speed, and is not a malfunction.

The flash is not activated.

- When the electronic shutter is used, the flash is not activated.
- When [Silent Mode] is set to [ON], the flash is not activated.

**The picture is not played back.
There are no recorded pictures.**

- Is the card inserted?
- Is this a folder or picture which was processed in the PC?
If it is, it cannot be played back by this unit.
→ It is recommended to use the software "PHOTOfunSTUDIO" (P57) to write pictures from PC to card.
- Has [Playback Mode] been set for playback?
→ Change to [Normal Play].

Cannot play back motion pictures.

- Motion pictures recorded with a different [System Frequency] setting cannot be played back. (P51)
→ Return the [System Frequency] setting to the one you used during the recording.

**A Wi-Fi connection cannot be established.
Radio waves get disconnected.
Wireless access point is not displayed.**

■ General tips for using a Wi-Fi connection

- Use within the communication range of the device to be connected.
- Is any device, such as microwave oven, cordless phone, etc., that uses 2.4 GHz frequency operated nearby?
→ Radio waves may get interrupted when used simultaneously. Use them sufficiently away from the device.
- When the battery indicator is flashing red, the connection with other equipment may not start or the connection may be disrupted.
(A message such as [Communication error] is displayed.)
- If you place the camera on a metal table or shelf, the radio waves may be adversely affected. In such cases, you may not be able to establish a connection. Move the camera away from the metal surface.

■ About a wireless access point

- Check if the wireless access point to connect is in operating state.
- Check the radio wave condition of the wireless access point.
→ Move this unit closer to the wireless access point.
→ Change the location and orientation of the wireless access point.
- It may not display even if the radio waves exist depending on the setting of the wireless access point.
→ Check the settings of the wireless access point.
→ When the network SSID of the wireless access point is set not to broadcast, the wireless access point may not be detected. Enter the network SSID to start the connection or enable the SSID broadcast of the wireless access point.

When I try to set up a Wi-Fi connection with a Windows 8 PC, my user name and password are not recognised, so I cannot connect to the PC.

- Some OS versions, including Windows 8, use two types of accounts: a local account and a Microsoft account.
→ Be sure to use the user name and password for the local account.
If you haven't set up a local account, please create one.

The PC is not recognised when I use a Wi-Fi connection. The camera cannot be connected to PC via Wi-Fi connection.

- The default workgroup name is set to "WORKGROUP". If you changed the workgroup name, the PC will not be recognised.
In [Change Workgroup Name] in [PC Connection] of the [Wi-Fi Setup] menu, change the workgroup name to that of the PC you are connecting to.
- Please confirm login name and password are correctly typed.
- When the system time of Mac computer or Windows PC connected to a camera differs severely from that of the camera, the camera cannot be connected to the computer or PC in some OSs.
→ Please confirm [Clock Set] and [World Time] of the camera matches with time, date and time zone in Windows PC or Mac computer. When both settings do not match severely, please match them.

**It takes time to transmit an image to the web service.
Transmission of the image fails midway. Some images cannot be transmitted.**

- Is the size of the image too large?
→ Reduce the image size at [Size], and then send.
→ Transmit after dividing the motion picture with [Video Divide].
- It may take longer time to transmit when distance to the wireless access point is far.
→ Transmit closer to the wireless access point.
- File format of the motion picture that can be sent differs depending on the destination.

There is a sound from lens unit.

- It is a sound of lens movement or aperture operation when this unit is turned on or off, and it is not a malfunction.
- The sound, which is caused by the automatic adjustment of the aperture, is heard when the brightness has changed due to, for example, zooming or the movement of the camera. This is not a malfunction.

Zooming stops instantaneously.

- When using the Extra Optical Zoom, the zooming action will stop temporarily. This is not a malfunction.

The camera becomes warm.

- The surface of the camera and the reverse side of the monitor may become warm during use. This does not affect the performance or quality of the camera.

The clock is reset.

- If you do not use the camera for a long time, the clock may be reset.
→ [Please set the clock] message will be displayed; please reset the clock. (P16)

Specifications

Specifications are subject to change without notice.

Digital Camera:

Information for your safety

Power Source:	DC 8.4 V (--- 8.4 V)
Power Consumption:	2.5 W (When recording with Monitor) 3.1 W (When recording with Viewfinder) 1.6 W (When playing back with Monitor) 1.7 W (When playing back with Viewfinder)
Camera effective pixels	20,100,000 pixels
Image sensor	1" MOS sensor, total pixel number 20,900,000 pixels, Primary colour filter
Lens	Optical 20× zoom, f = 8.8 mm to 176 mm (35 mm film camera equivalent: 24 mm to 480 mm) Wide: F2.8 to F11 Tele: F4.5 to F11
ND filter	[AUTO]/[1/4]/[1/16]/[1/64]/[OFF]
Image Stabiliser	Optical method
Focus range	
AF	30 cm (0.98 feet) (Wide)/1 m (3.3 feet) (Tele) to ∞
AF Macro/MF/ Intelligent Auto/ Motion Picture	3 cm (0.098 feet) (Wide)/1 m (3.3 feet) (Tele) to ∞
Shutter system	Electronic shutter+Mechanical shutter
Minimum Illumination	Approx. 9 lx [when i-Low light is used, the shutter speed is 1/30th of a second (When [System Frequency] is set to [59.94 Hz (NTSC)]) or 1/25th (When [System Frequency] is set to [50.00 Hz (PAL)])]

Shutter speed		
Still picture	B (Bulb) (Max. approx. 120 second), 60 to 1/4000th seconds (with the mechanical shutter) 1 to 1/16000th seconds (with the electronic shutter)	
Motion picture	1/30th of a second to 1/16000th of a second (When [System Frequency] is set to [59.94 Hz (NTSC)])/ 1/25th of a second to 1/16000th of a second (When [System Frequency] is set to [50.00 Hz (PAL)])/ 1/24th of a second to 1/16000th of a second (When [System Frequency] is set to [24.00 Hz (CINEMA)]) 1/2th of a second to 1/16000th of a second (When [M] is selected in Creative Video Mode, MF)	
Exposure (AE)	Programme AE (P)/Aperture-Priority AE (A)/ Shutter-Priority AE (S)/Manual Exposure (M)/AUTO	
Light metering mode	Multiple/Centre weighted/Spot	
Monitor	3.0" TFT LCD (3:2) (Approx. 1,040,000 dots) (field of view ratio about 100%) Touch screen	
Viewfinder	OLED Live Viewfinder (4:3) (Approx. 2,360,000 dots) (field of view ratio about 100%) (with diopter adjustment -4 to +4 diopter)	
Flash	Built-in pop up flash AUTO, AUTO/Red-Eye Reduction, Forced ON, Forced ON/ Red-Eye Reduction, Slow Sync., Slow Sync./Red-Eye Reduction, Forced OFF	
Microphone	Stereo	
Speaker	Monaural	
Recording media	SD Memory Card/SDHC Memory Card*/SDXC Memory Card* (* UHS-I UHS Speed Class 3)	
Recording file format		
Still Picture	RAW/JPEG (based on "Design rule for Camera File system", based on "Exif 2.3" standard, DPOF corresponding)	
Motion pictures	AVCHD Progressive/AVCHD/MP4/MOV	
Audio compression	AVCHD	Dolby® Digital (2 ch)
	MP4	AAC (2 ch)
	MP4 (LPCM), MOV	LPCM (2 ch)

Interface	
Digital	"USB 2.0" (High Speed) * Data from the PC can not be written to the camera using the USB connection cable.
Terminal	
[REMOTE]	∅ 2.5 mm jack
[MIC]	∅ 3.5 mm jack
Headphone	∅ 3.5 mm jack
[HDMI]	MicroHDMI Type D
USB	USB 2.0 Micro-B
Dimensions	Approx. 137.6 mm (W)×101.9 mm (H)×134.7 mm (D) [5.42"(W)×4.01"(H)×5.30"(D)]
Mass	Approx. 966 g/2.13 lb (with card and battery) Approx. 915 g/2.02 lb (excluding card and battery)
Operating temperature	0 °C to 40 °C (32 °F to 104 °F)
Operating humidity	10%RH to 80%RH
Wireless transmitter	
Compliance standard	IEEE 802.11b/g/n (standard wireless LAN protocol)
Frequency range used (central frequency)	2412 MHz to 2462 MHz (1 to 11ch)
Encryption method	Wi-Fi compliant WPA™/WPA2™
Access method	Infrastructure mode

Battery Charger (Panasonic DE-A80A):

Information for your safety

Input:	AC ~ 110 V–240 V 50/60 Hz 0.2 A
Output:	DC = 8.4 V 0.65 A

Battery Pack (lithium-ion) (Panasonic DMW-BLC12E):

Information for your safety

Voltage/capacity:	7.2 V/1200 mAh
--------------------------	----------------

The symbols on this product (including the accessories) represent the following:

~	AC
=	DC
□	Class II equipment (The construction of the product is double-insulated.)

Digital Camera Accessory System

Description	Accessory#
Battery Pack	DMW-BLC12
AC Adaptor*	DMW-AC10
DC Coupler*	DMW-DCC8
MC Protector	DMW-LMCH67
PL Filter (Circular Type)	DMW-LPL67
LED Video Light	VW-LED1
Flash	DMW-FL200L, DMW-FL360L, DMW-FL580L
Stereo Shotgun Microphone	DMW-MS2
Stereo Microphone	VW-VMS10
Shutter Remote Control	DMW-RSL1
Upgrade Software Key	DMW-SFU1

* The AC Adaptor (optional) can only be used with the designated Panasonic DC Coupler (optional). The AC adaptor (optional) cannot be used by itself.

Product numbers correct as of September 2016. These may be subject to change.

- Some optional accessories may not be available in some countries.
- NOTE: Accessories and/or model numbers may vary between countries. Consult your local dealer.

Sales and Support Information

Customer Communications Centre

- For customers within the UK: 0344 844 3899
- For customers within Ireland: 01 289 8333
- Monday – Friday 9:00 am – 5:00 pm (Excluding public holidays).
- For further support on your product, please visit our website:
www.panasonic.co.uk

Direct Sales at Panasonic UK

- Order accessory and consumable items for your product with ease and confidence by phoning our Customer Communications Centre Monday – Friday 9:00 am – 5:00 pm (Excluding public holidays).
- Or go on line through our Internet Accessory ordering application at www.pas-europe.com.
- Most major credit and debit cards accepted.
- All enquiries transactions and distribution facilities are provided directly by Panasonic UK.
- It couldn't be simpler!
- Also available through our Internet is direct shopping for a wide range of finished products. Take a browse on our website for further details.

Reading the Operating Instructions (PDF format)

More detailed operating instructions are available in “Operating Instructions for advanced features (PDF format)”. To read it, download it from the website.

<http://panasonic.jp/support/dsc/oi/index.html?model=DMC-FZ2000&dest=EB>



- Click the desired language.

■ To check the URL and QR code on the camera

Select the menu. (P22)

MENU →  [Setup] → [Online Manual]	
[URL display]	Displays the URL of the website on the camera's monitor.
[QR Code display]	Displays the QR code on the camera's monitor.

- You will need Adobe Reader to browse or print the “Operating Instructions for advanced features (PDF format)”.

You can download and install a version of Adobe Reader that you can use with your OS from the following website. (As of September 2016)

<http://www.adobe.com/products/acrobat/readstep2.html>

This product incorporates the following software:

- (1) the software developed independently by or for Panasonic Corporation,
- (2) the software owned by third party and licensed to Panasonic Corporation, and/or
- (3) open source software

The software categorised as (3) is distributed in the hope that it will be useful, but WITHOUT ANY WARRANTY, without even the implied warranty of MERCHANTABILITY or FITNESS FOR A PARTICULAR PURPOSE.

Please refer to the detailed terms and conditions thereof displayed by selecting [MENU/SET] → [Setup] → [Version Disp.] → [Software info].

- SDXC Logo is a trademark of SD-3C, LLC.
- “AVCHD”, “AVCHD Progressive” and the “AVCHD Progressive” logo are trademarks of Panasonic Corporation and Sony Corporation.
- Manufactured under license from Dolby Laboratories. Dolby and the double-D symbol are trademarks of Dolby Laboratories.
- The terms HDMI and HDMI High-Definition Multimedia Interface, and the HDMI Logo are trademarks or registered trademarks of HDMI Licensing, LLC in the United States and other countries.
- HDAVI Control™ is a trademark of Panasonic Corporation.
- Adobe is a trademark or registered trademark of Adobe Systems Incorporated in the United States and/or other countries.
- Pentium is a trademark of Intel Corporation in the U.S. and/or other countries.
- iMovie, Mac and Mac OS are trademarks of Apple Inc., registered in the U.S. and other countries.
- iPad, iPhone, iPod, and iPod touch are trademarks of Apple Inc., registered in the U.S. and other countries.
- App Store is a service mark of Apple Inc.
- Windows is a registered trademark or trademark of Microsoft Corporation in the United States and/or other countries.
- Android and Google Play are trademarks or registered trademarks of Google Inc.



- QuickTime and the QuickTime logo are trademarks or registered trademarks of Apple Inc., used under license therefrom.
- The Wi-Fi CERTIFIED™ Logo is a certification mark of Wi-Fi Alliance®.
- The Wi-Fi Protected Setup™ Identifier mark is a certification mark of Wi-Fi Alliance®.
- “Wi-Fi®” is a registered trademark of Wi-Fi Alliance®.
- “Wi-Fi Protected Setup™”, “WPA™”, and “WPA2™” are trademarks of Wi-Fi Alliance®.
- DLNA, the DLNA Logo and DLNA CERTIFIED are trademarks, service marks, or certification marks of the Digital Living Network Alliance.
- This product uses “DynaFont” from DynaComware Corporation. DynaFont is a registered trademark of DynaComware Taiwan Inc.
- QR Code is a registered trademark of DENSO WAVE INCORPORATED.
- Other names of systems and products mentioned in these instructions are usually the registered trademarks or trademarks of the manufacturers who developed the system or product concerned.



This product is licensed under the AVC Patent Portfolio License for the personal use of a consumer or other uses in which it does not receive remuneration to (i) encode video in compliance with the AVC Standard (“AVC Video”) and/or (ii) decode AVC Video that was encoded by a consumer engaged in a personal activity and/or was obtained from a video provider licensed to provide AVC Video. No license is granted or shall be implied for any other use. Additional information may be obtained from MPEG LA, L.L.C.

See <http://www.mpegla.com>

Manufactured by: Panasonic Corporation
Kadoma, Osaka, Japan
Importer for Europe: Panasonic Marketing Europe GmbH
Panasonic Testing Centre
Winsbergring 15, 22525 Hamburg, Germany



Panasonic Corporation

Web Site: <http://www.panasonic.com>

© Panasonic Corporation 2016