



Aeon AcousticPro UHD Series

EDGE FREE® Fixed Frame Sound Transparent Projection Screen











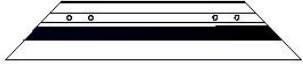

User's Guide

Product Description: The Aeon *AcousticPro UHD* Series is a fixed frame projection screen that uses Elite's EDGE FREE™ technology. The EDGE FREE® design resembles a giant size flat panel TV display. The Aeon includes **Edge trim** as an installation option to further enhance the frame appearance and absorb projector overshoot. An optional LED backlighting kit is available for added visual appearance.

For more information on the LED kit please visit: <http://www.elitescreens.com/led>

Hardware and Parts List

Please make sure all parts listed below are included before installation.

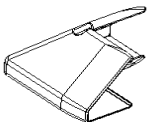
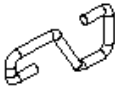
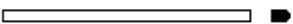
A. Elbow joint x 4 pcs	B. Top/Bottom horizontal frame x 4 pcs	C. Left/Right vertical frame x 2 pcs
		
D. Center joints x 2 pcs	E. Center Support bar x 1-2 pc	F. Wall brackets x 2-3 pcs
		
G. M6 screw x 2-12 pcs	H. M5x15 screw x 24 pcs	I. M6x12 screw x 2-12pcs
		
J. M5x50 screws and anchor x 6 pcs	K. Black Tape x 1 bag	L. Edge trim x6 pcs
		
M. Plastic corner sleeve x 4 pcs	N. Hook	O. Fiberglass rod x 6 pcs & Plastic sleeve x 12 pcs
		

Frame Assembly

1. Insert the center joint into one of the $\frac{1}{2}$ *horizontal frames* (B) and fasten it with the two *M5x15 screws* (H).
2. Insert the other $\frac{1}{2}$ horizontal frame piece to the center joint and fasten also using two *M5x15 screws*.
3. Repeat steps 1 and 2 for assembling the second horizontal frame.

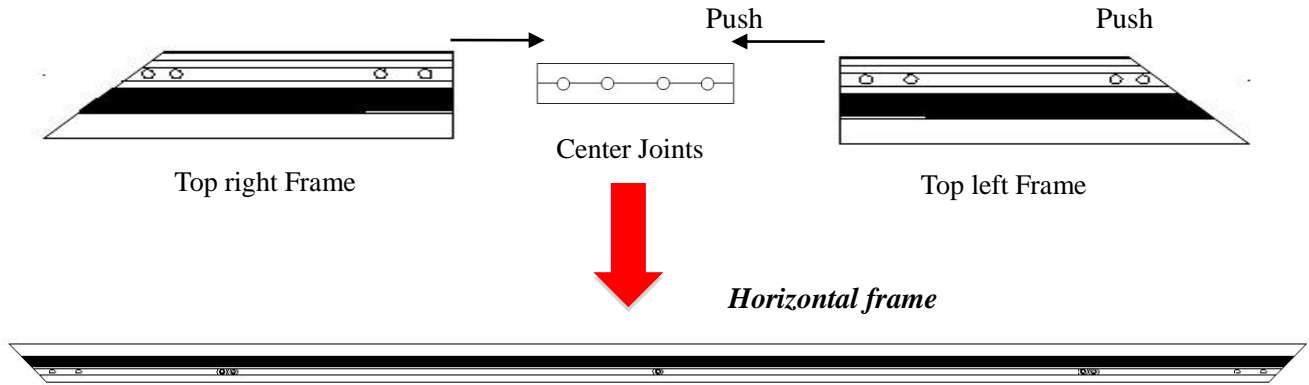

4. Insert and slide in one *M6 screws* (G) through the channel located on the back each *horizontal frame*.

M6 hex screws (G)

Horizontal long frame

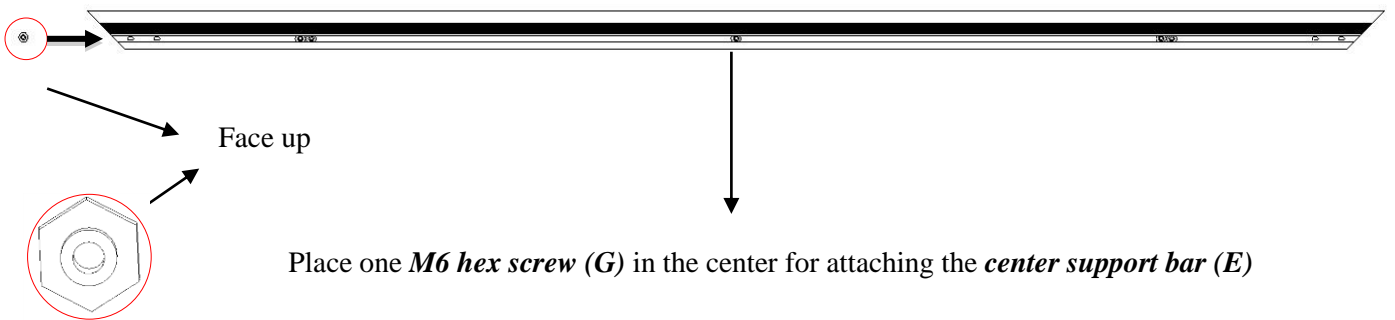

5. Insert the *elbow joint* (A) into each end of the *horizontal frames* (B) as shown below.

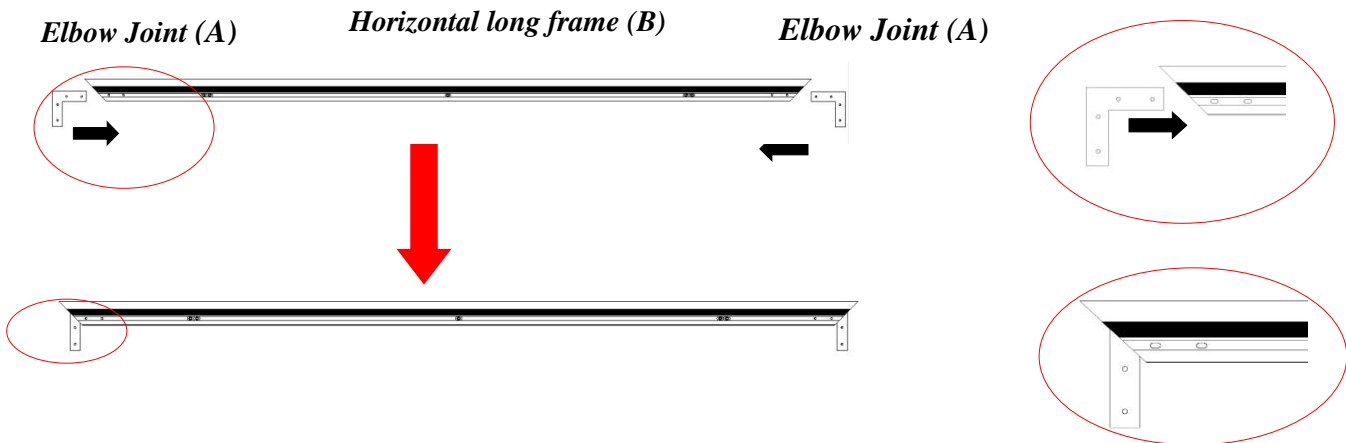

6. Insert the two *vertical short frames (C)* into the *elbow joint (A)*.

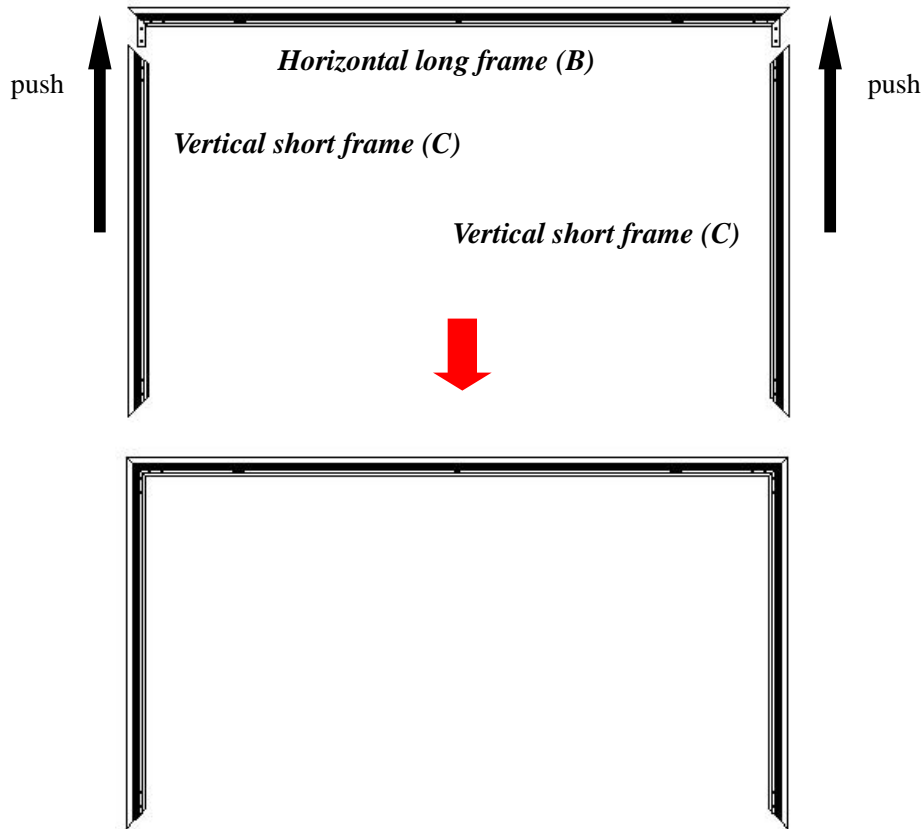

7. Join the remaining *horizontal long frame (B)* with the frame built in the previous steps as shown below.

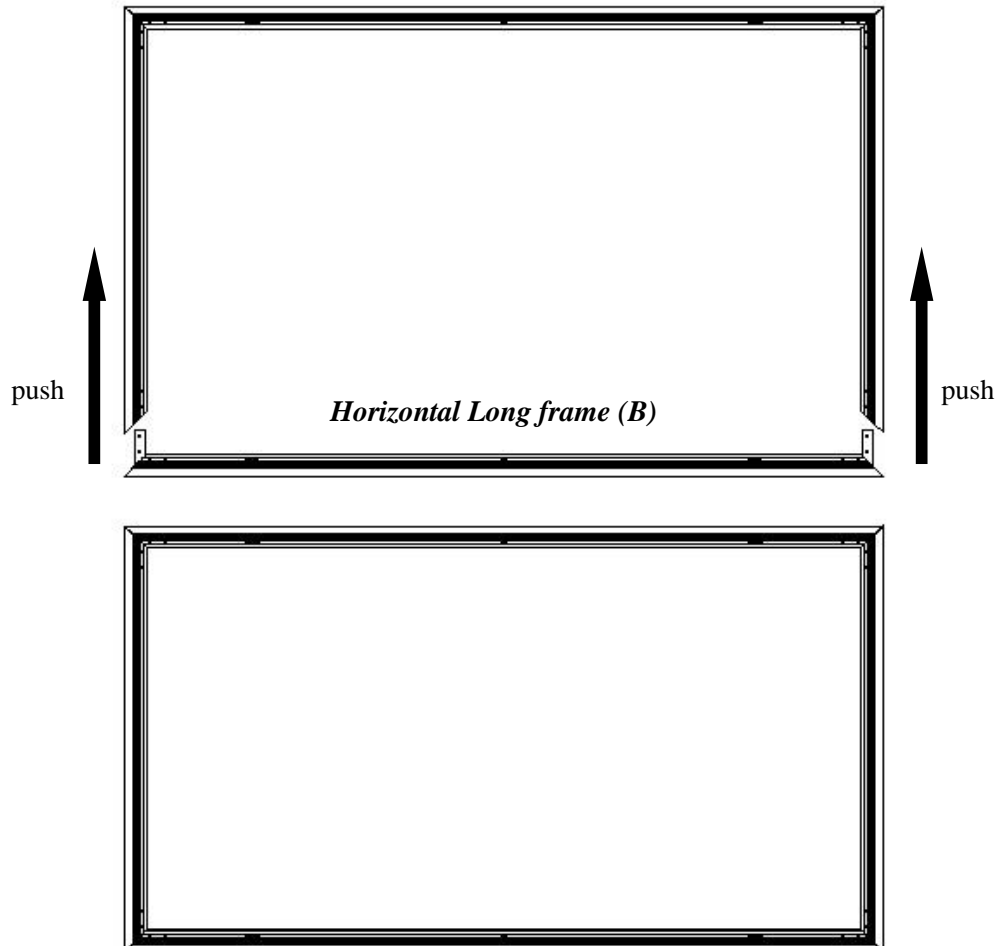

8. Make sure all four corners are properly in place to form a perfect square. Then fasten the four angles with the **M5x15 Screws (H)**.

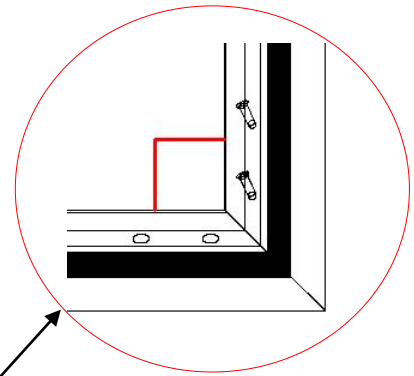
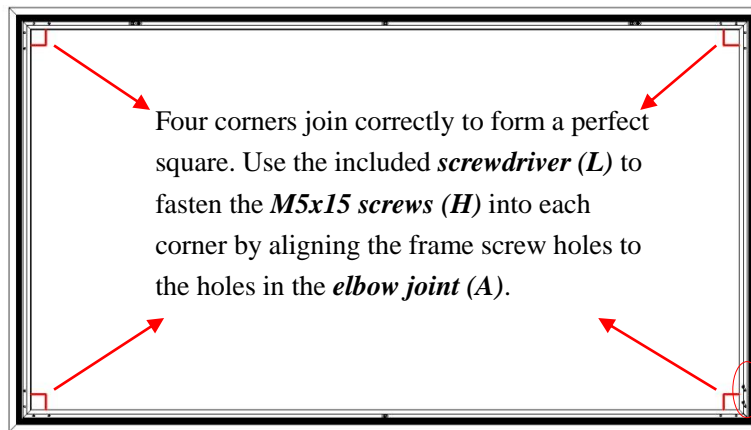

Screen Material Installation

1. Lay the **screen material** completely flat with the front facing down on a clean surface in a horizontal position. The back side of the screen material should be placed upwards.

Note: The back side of the material has the velcro borders all around the edges.

2. Carefully and gently place the assembled frame on top the screen material as shown below. Make sure to not allow the angle edge of the frame to come in direct contact with the screen material to avoid puncturing it.

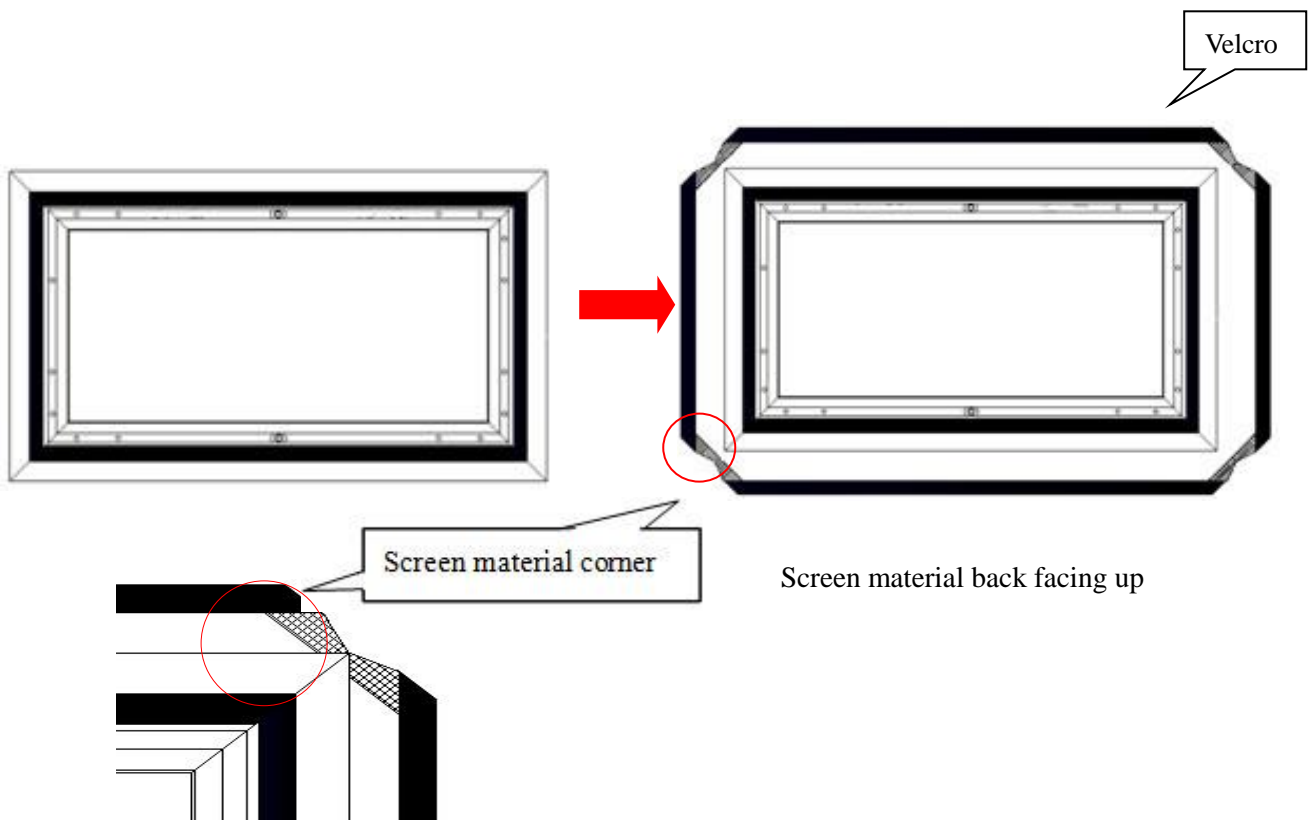

3. After all of the corners of the frame have been properly aligned, attach the material to the frame in the following order A→B→C→D (see instructions below for details).

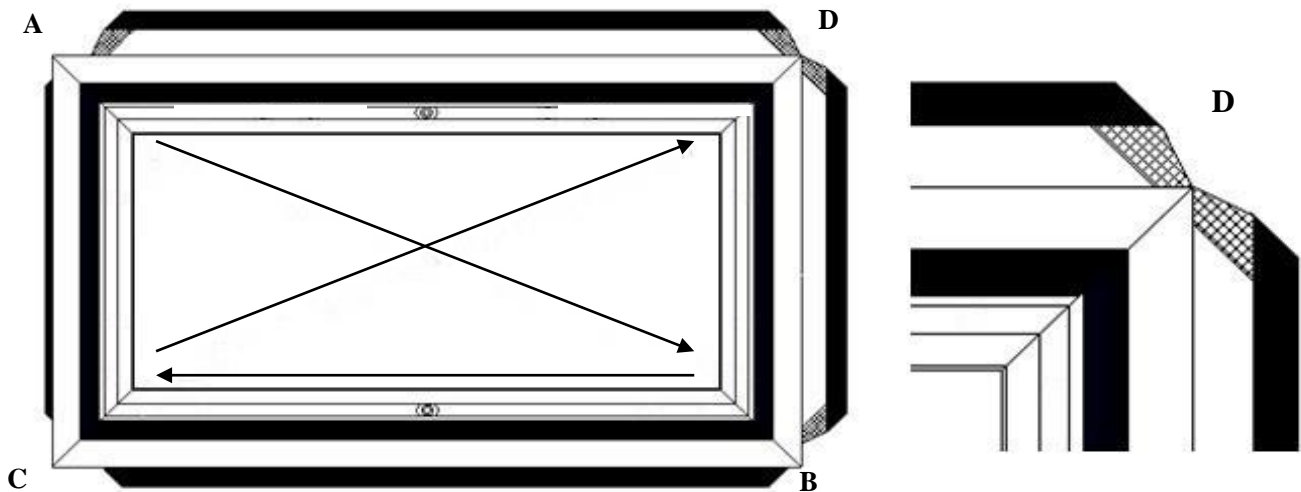

Attach the screen material to the corners as shown below.

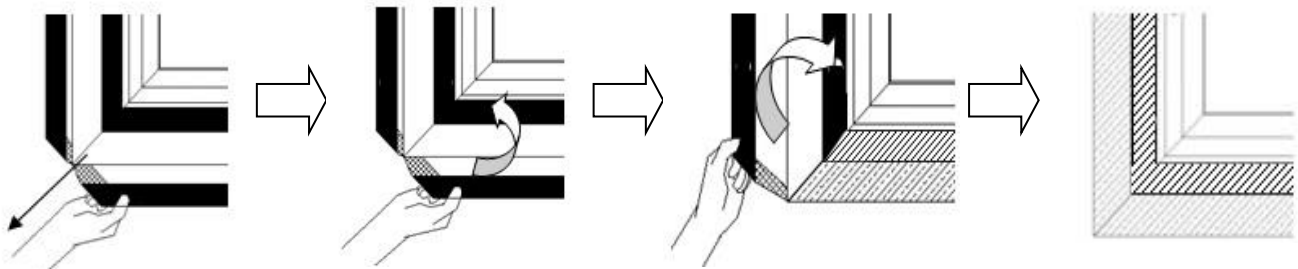

1) Stretch the screen material in the direction of the arrowhead.

2) Fold over and attach material to the velcro strip of the frame.

3) Fold over second side and attach to frame

4) Repeat until all four sides are done in the order A, B, C, D

4. After all four corners have been attached; please check whether the frame corners are wrapped by the screen material. If not, please loosen the velcro connection and repeat the above steps so the frame is not exposed.

Note:

Represents the screen material

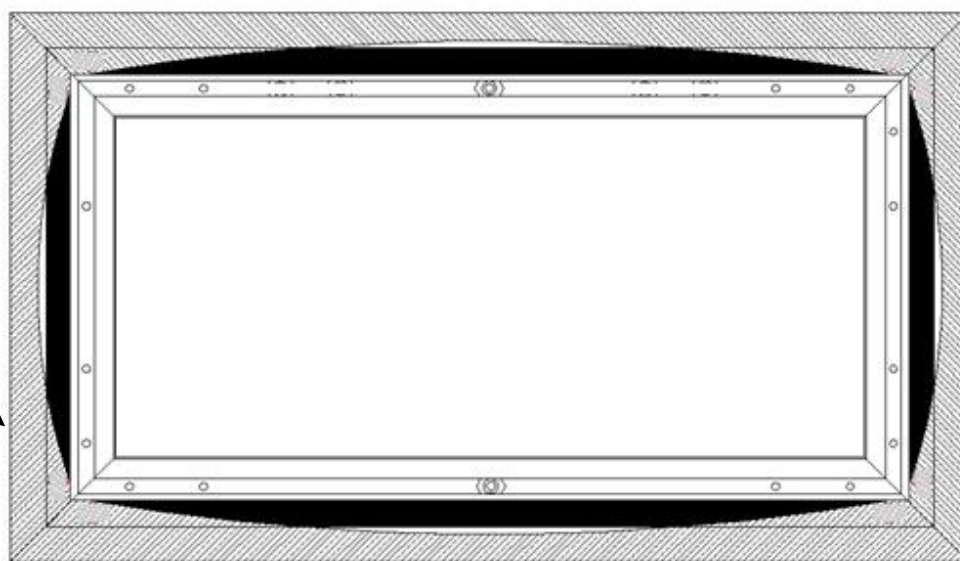

Note: The black shaded part represents the velcro on the frame. That Velcro end will ultimately attach with the other velcro end on the screen material.

5. Proceed to attach the rest of the material to the frame as described in the illustrations below.

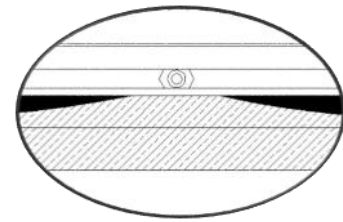
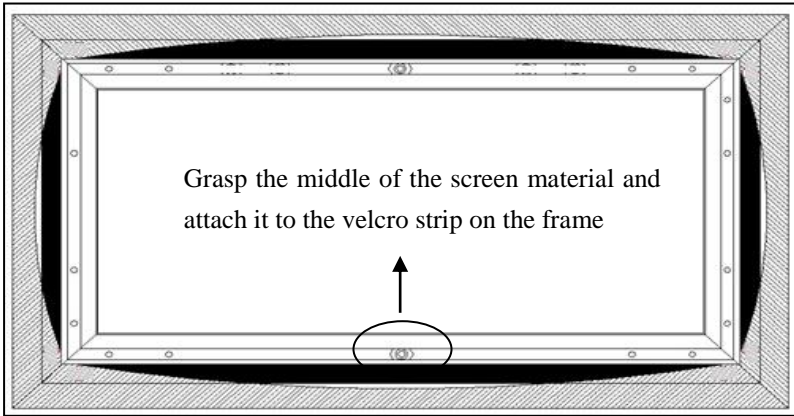

Lay the Velcro end on the screen material over the Velcro end of the frame and keep it within the edge.

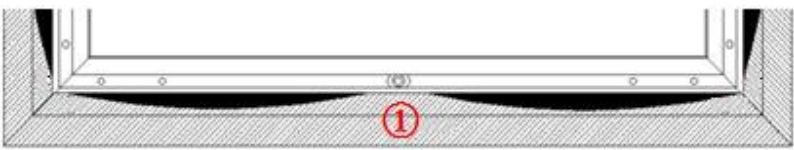

Proceed in the following sequence below ①→②

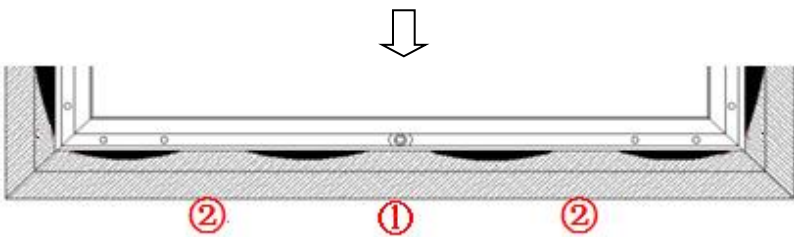

The key is to attach within the middle sections of 1 and 2. Then continue attaching the remaining unattached areas.

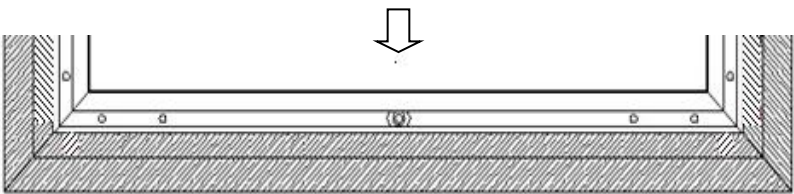

Repeat the same steps on remaining three sides in the sequence A, B, C, D as show below.

A

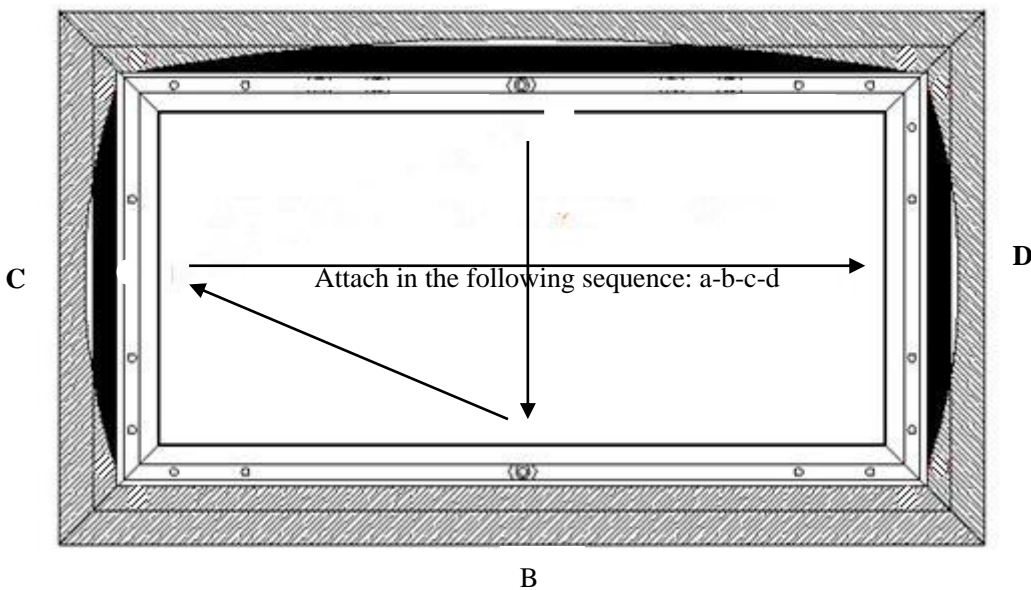

Screen Material Removal

Follow the steps to properly remove the screen material from the frame. This procedure will ensure prolonging the life of the screen material.

1. Detach the velcro from the frame.
2. Gently pull back the material to release the material from the velcro connections on the corners.

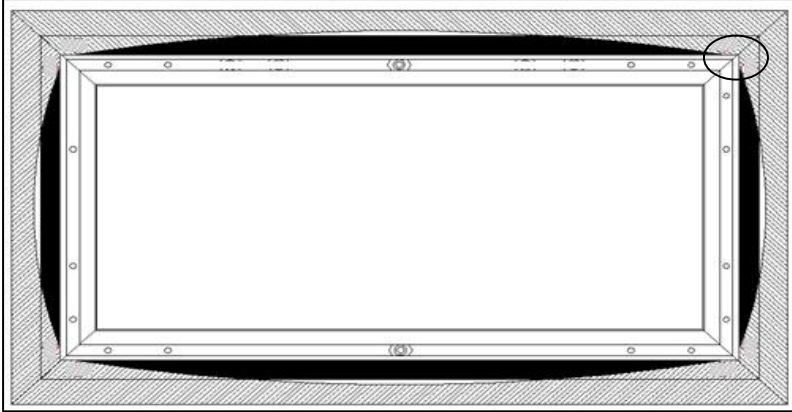

Pull back the screen material from the velcro connection along the edges of the frame to detach it.

Support bar installation (for models under 180")

1. Position the *center support bar (E)* in the middle of the frame and align the hole on each end of the support bar with the *M6 hex screws (G)* on the top and bottom frames. Then fasten with the *M6x12 screws (I)*.

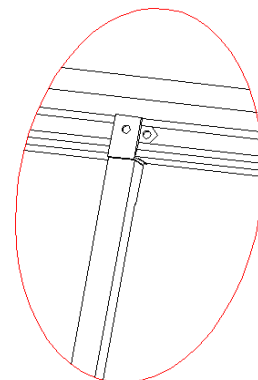
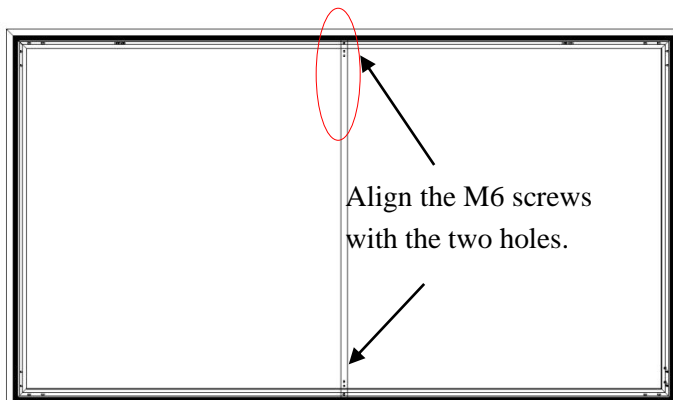
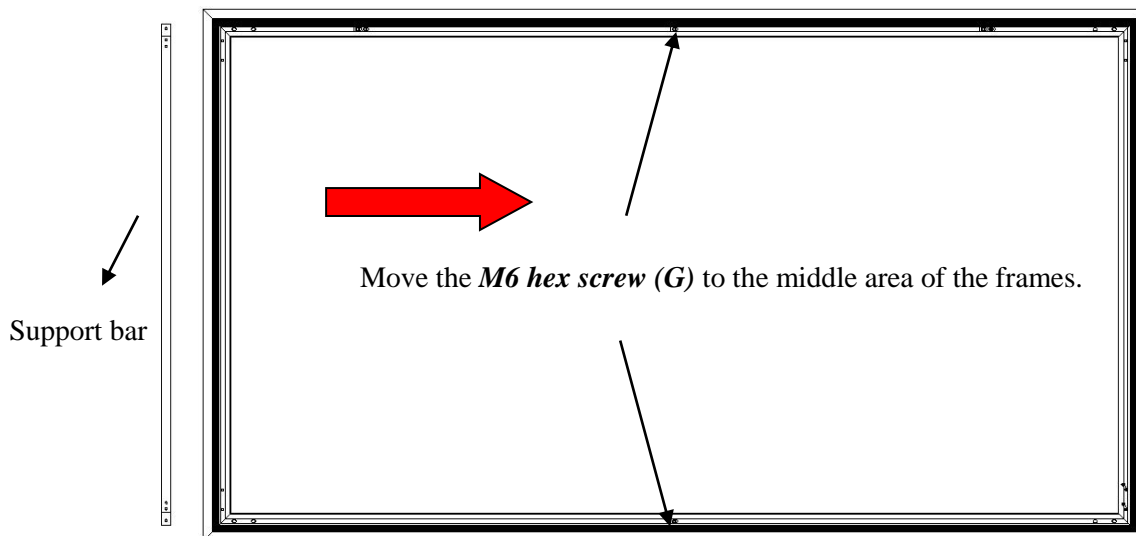

Black Backing Installation

1. Lay the Black backing completely flat with the opening side facing down on the white (AcousticPro UHD) material in a horizontal position under the center support bar.

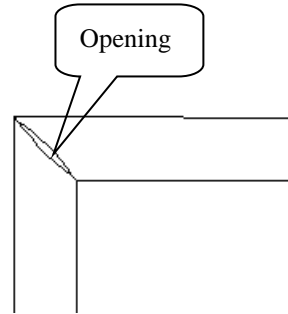
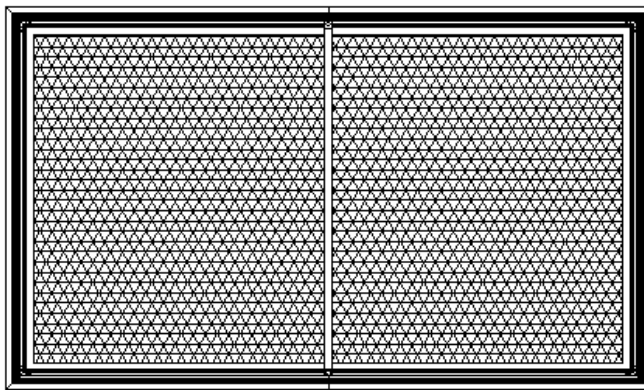

2. Put the plastic sleeves on the fiberglass rods.

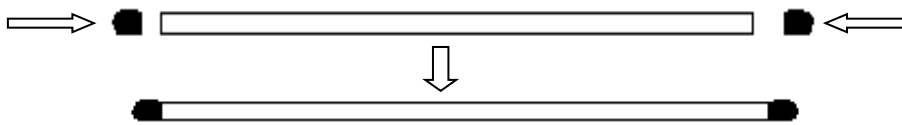

3. Insert the fiberglass rods through the openings. The longer rods are used on the vertical edges of the screen material, and the shorter rods are used on the horizontal edges, as shown below.

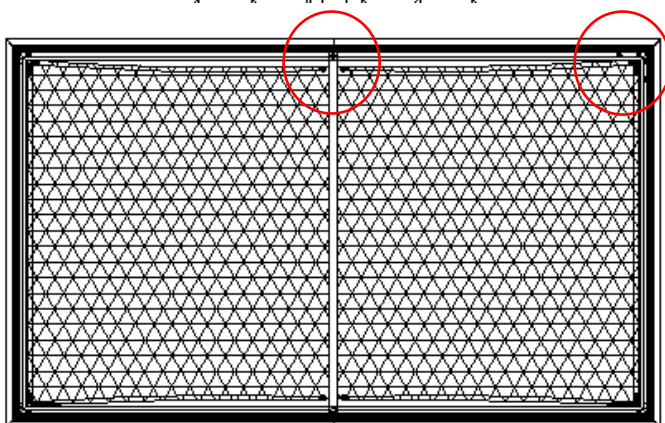
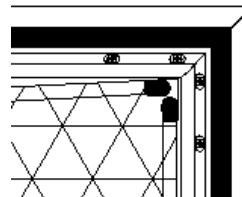
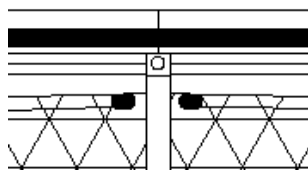
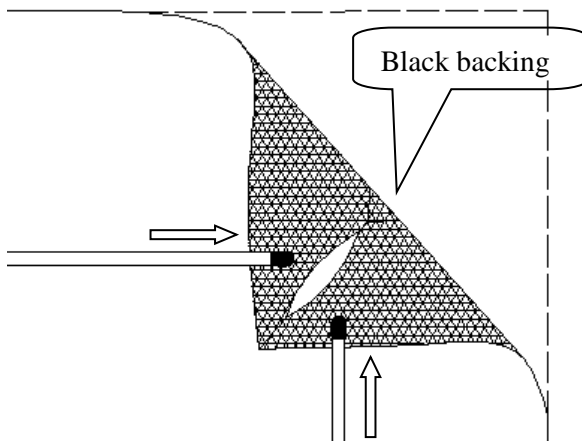

4. Hook installation

- 1) Follow steps ① ② ③ on Fig. 1 to properly affix the hook to the frame as shown in Fig. 2.
- 2) Affix the hooks on the red arrow marks (Fig. 3).

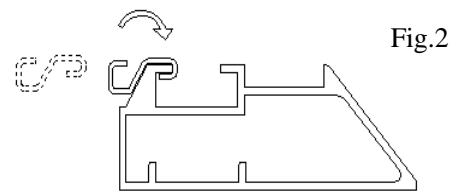
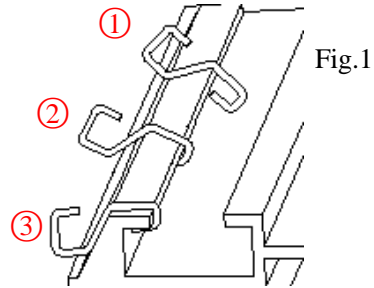
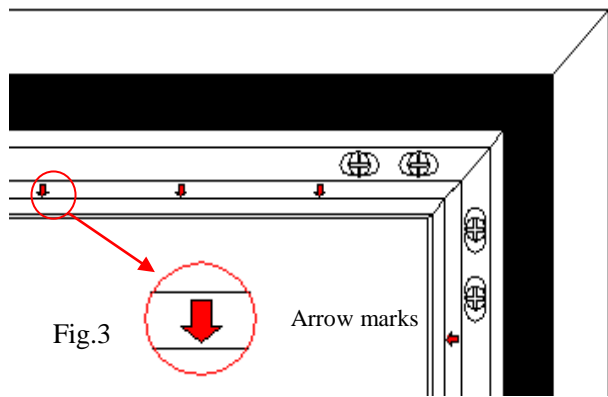

Example of properly affixed hook to the frame.

NOTE: Make sure the hooks are affixed correctly as they are not easy to remove from the black mesh backing once they have been affixed.

5. Black backing material attachment into the hooks.

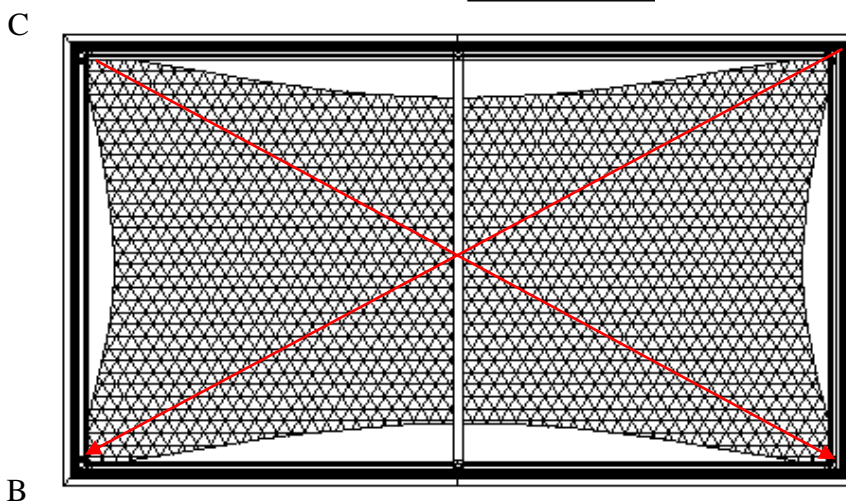
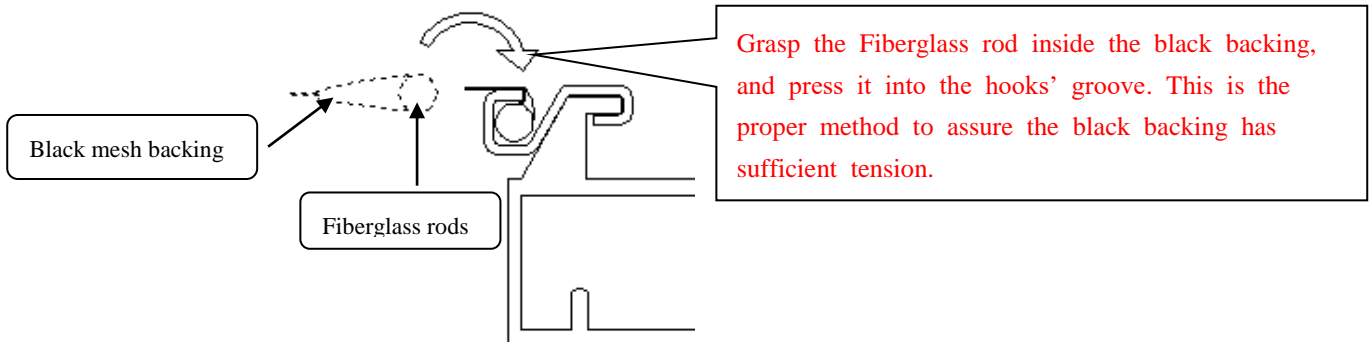

First, stretch the four corners of the black backing and insert into the first two hooks on each corner in the following sequence A→B→C→D.

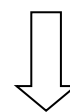

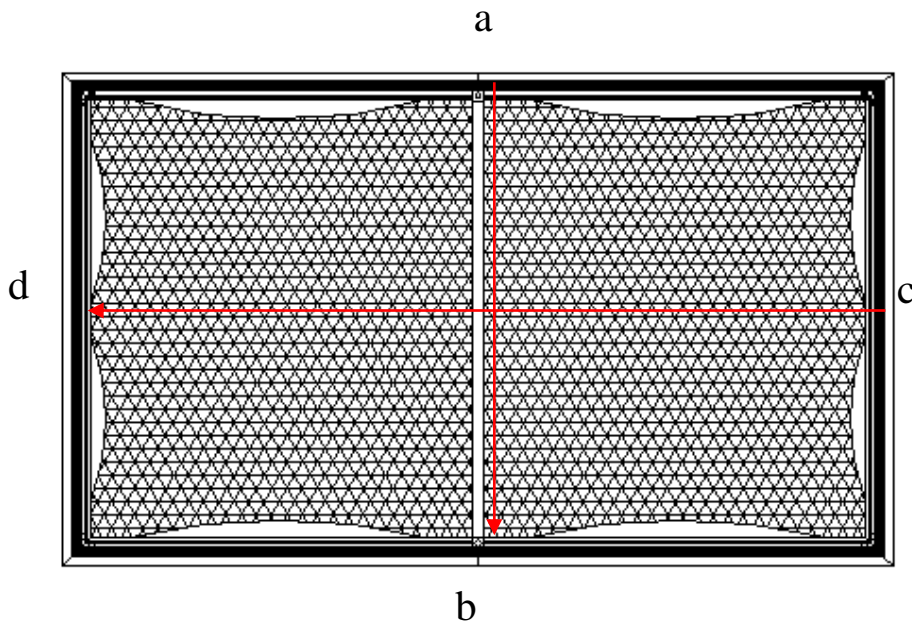

Next, stretch the black backing and affix to the hooks from the middle in the following sequence a→b→c→d

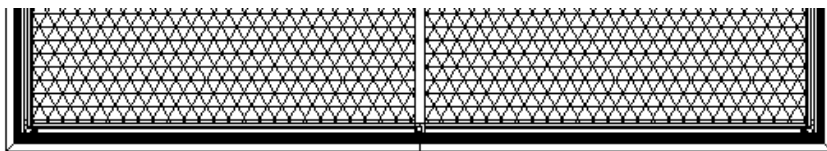
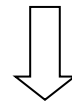

Lastly, affix the black backing to the remaining hooks. Add more hooks as needed to achieve flatter results in the areas that are not flat.

Edge trim Installation

The Aeon fixed screen is edge free, but you may install the **Edge trim** to provide it with an elegant thin bezel finish.



Edge trim x 6 pcs



Black tape x1 bag

1. Put the assembled frame face up on a flat and clean surface and stick a piece of black tape on the center of the top and bottom of the screen. Please align the tape with the edge of the screen, as shown below.

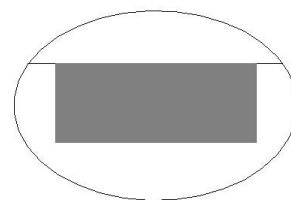
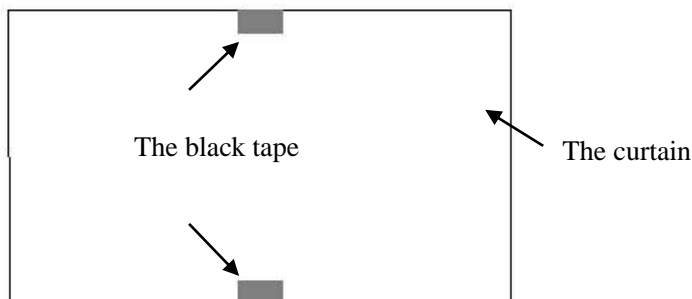

The black tape

2. Then align and adjust the edge trim with the screen edge to make the four corners. Make sure the strip with the Elite Screens logo is on the bottom right.

Note: Do not remove the tape on the back of the trim just yet.

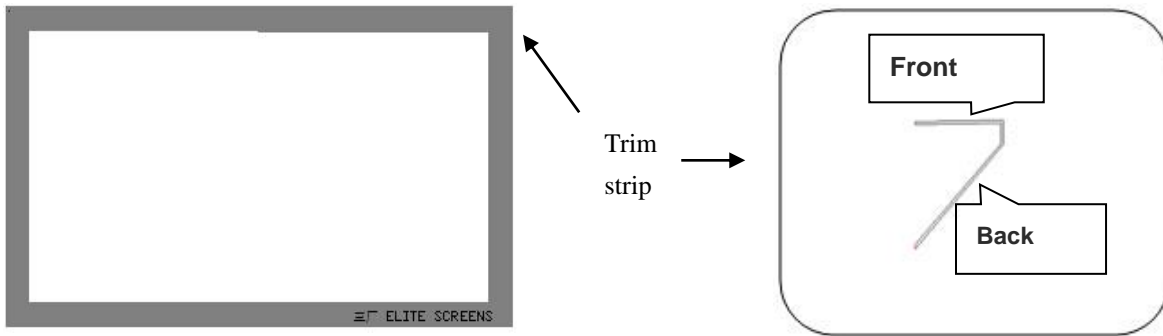

3. After aligning all four strips, take down trim **A**, peel off the tape from the back and stick the strip back on the aligned location.

Repeat Step 3 in the following order B-C-D-E-F for the remaining edge trim strips.

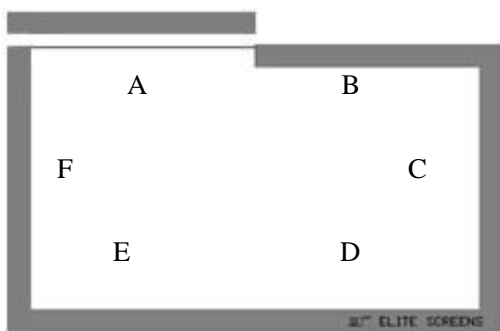

The **front side** of the frame with trims

4. After the edge trim has been installed, place a **Plastic corner sleeve (M)** on all four corners. Begin by aligning and adjusting the corner sleeve through the front of the screen. Make sure the plastic corner sleeve completely wraps the edge of the edge trim.

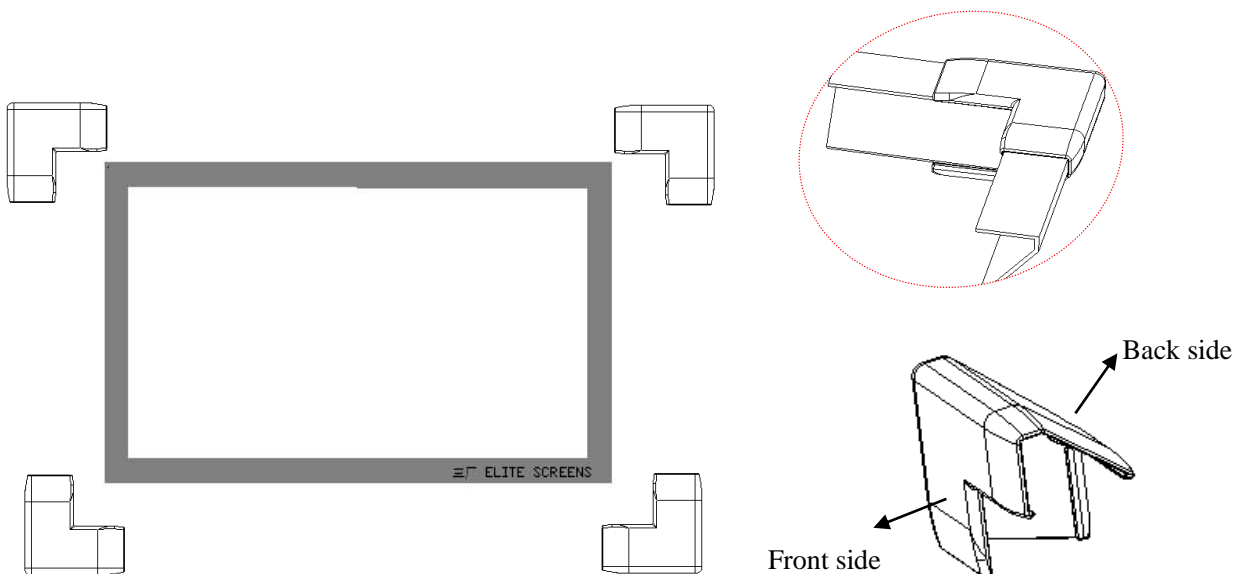

Once all corner sleeves have been snapped into each corner of the frame, it is ready to be installed.

Attention: Installing the edge trim will reduce the viewing size of your screen. See below illustrations for a comparison of the viewing size of the before and after edge trim installation using the 100" & 120" 16:9 diagonal models.

100" comparison:

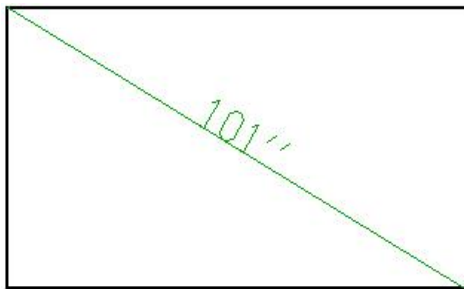

Before installing the edge trim

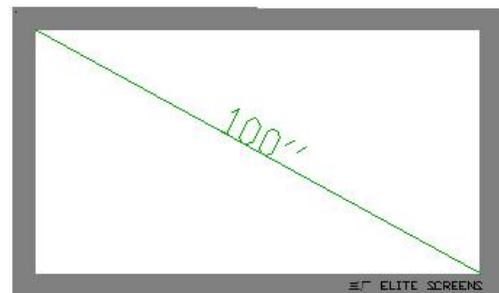

After installing the edge trim

120" comparison:

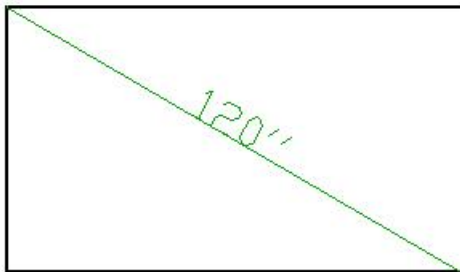

Before installing the edge trim

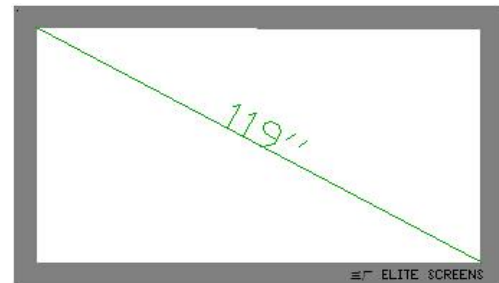

After installing the edge trim

Installation

Locate your desired installation location with a stud finder (recommended) and mark the drill-hole area of where the screen is to be installed.

1. Drill a hole with the proper bit size according to the wood screws included.
2. Line up the wall brackets with the drilled holes on the installation location and screw them in using a Phillips screwdriver.
3. Position the frame screen onto the **wall brackets** (F) as shown in **below**.
4. The design of the wall brackets allows the frame to slide over them through its sides. This is an important feature of the installation design as it allows your screen to be properly centered.

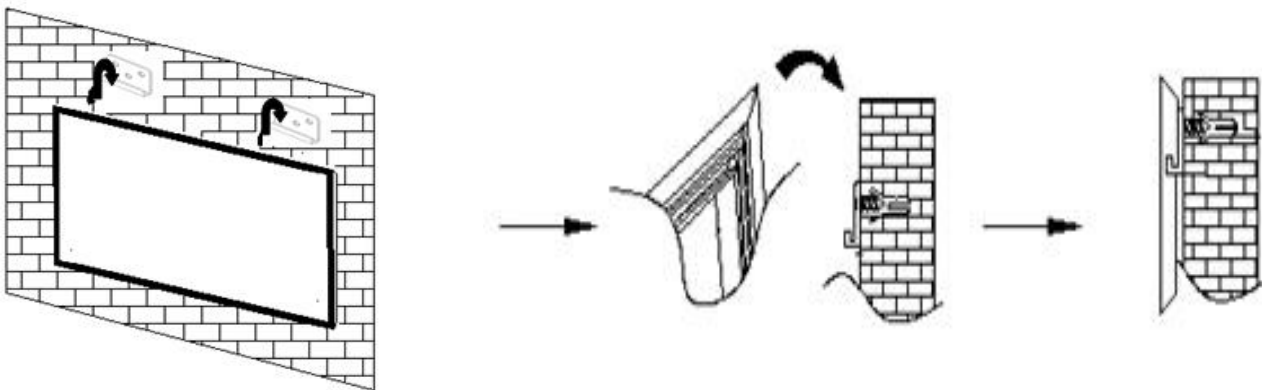

For a local Elite Screens contact or Technical Support, please visit

www.elitescreens.com