



Digital Projector  
**User Manual**

LX820ST / LW820ST

V1.00

# Warranty and Copyright information

## Limited warranty

BenQ warrants this product against any defects in material and workmanship, under normal usage and storage.

Proof of purchase date will be required with any warranty claim. In the event this product is found to be defective within the warranty period, BenQ's only obligation and your exclusive remedy shall be replacement of any defective parts (labor included). To obtain warranty service, immediately notify the dealer from which you purchased the product of any defects.

Important: The above warranty shall be void if the customer fails to operate the product in accordance with BenQ's written instructions, especially the ambient humidity must be in-between 10% and 90%, temperature in-between 0°C and 35°C, altitude lower than 4920 feet, and avoiding to operate the projector in a dusty environment. This warranty gives you specific legal rights, and you may have other rights which vary from country to country.

For other information, please visit [www.BenQ.com](http://www.BenQ.com).

## Copyright

Copyright © 2018 by BenQ Corporation. All rights reserved. No part of this publication may be reproduced, transmitted, transcribed, stored in a retrieval system or translated into any language or computer language, in any form or by any means, electronic, mechanical, magnetic, optical, chemical, manual or otherwise, without the prior written permission of BenQ Corporation.

## Disclaimer

BenQ Corporation makes no representations or warranties, either expressed or implied, with respect to the contents hereof and specifically disclaims any warranties, merchantability or fitness for any particular purpose. Further, BenQ Corporation reserves the right to revise this publication and to make changes from time to time in the contents hereof without obligation to notify any person of such revision or changes.

\*DLP, Digital Micromirror Device and DMD are trademarks of Texas Instruments. Others are copyrights of their respective companies or organizations.

## Patents

Please go to <http://patmarking.benq.com/> for the details on BenQ projector patent coverage.

# Table of Contents

<b>Warranty and Copyright information</b> .....	<b>2</b>
<b>Important safety instructions</b> .....	<b>4</b>
<b>Introduction</b> .....	<b>7</b>
Shipping contents .....	7
Projector exterior view .....	8
Controls and functions.....	9
<b>Positioning your projector</b> .....	<b>12</b>
Choosing a location .....	12
Obtaining a preferred projected image size.....	13
Mounting the projector .....	14
Adjusting the projected image .....	15
<b>Connection</b> .....	<b>17</b>
Connecting smart devices .....	19
<b>Operation</b> .....	<b>20</b>
Starting up the projector .....	20
Using the menus .....	21
Securing the projector .....	23
Switching input signal .....	24
Controlling the projector via LAN .....	25
Upgrading firmware via LAN.....	26
Controlling the projector remotely via a web browser .....	26
Shutting down the projector .....	29
Direct power off .....	29
<b>Menu operation</b> .....	<b>30</b>
<b>Basic</b> menu .....	30
<b>Advanced</b> menu .....	32
<b>Maintenance</b> .....	<b>40</b>
Care of the projector .....	40
Light information .....	41
<b>Troubleshooting</b> .....	<b>43</b>
<b>Specifications</b> .....	<b>44</b>
Projector specifications .....	44
Dimensions .....	45
Timing chart.....	46

# Important safety instructions

Your projector is designed and tested to meet the latest standards for safety of information technology equipment. However, to ensure safe use of this product, it is important that you follow the instructions mentioned in this manual and marked on the product.

1. **Please read this manual before you operate your projector.** Save it for future reference.

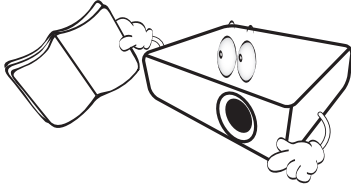

2. **Do not look straight at the projector lens during operation.** The intense light beam may damage your eyes.

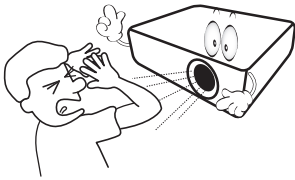

3. **Refer servicing to qualified service personnel.**

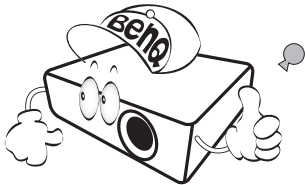

4. **Always open the lens shutter (if any) or remove the lens cap (if any) when the projector light source is on.**

5. The light source becomes extremely hot during operation. Allow the projector to cool for approximately 45 minutes prior to removing the light source assembly for replacement.

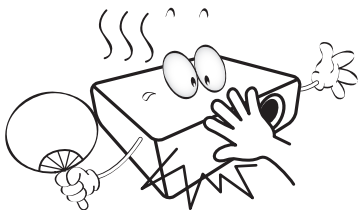

6. In some countries, the line voltage is NOT stable. This projector is designed to operate safely within a mains voltage between 100 to 240 volts AC, but could fail if power cuts or surges of  $\pm 10$  volts occur. **In areas where the mains voltage may fluctuate or cut out, it is recommended that you connect your projector through a power stabilizer, surge protector or uninterruptible power supply (UPS).**

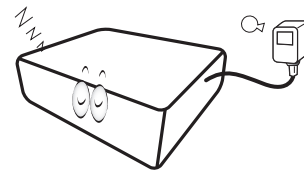

7. Do not block the projection lens with any objects when the projector is under operation as this could cause the objects to become heated and deformed or even cause a fire. To temporarily turn off the light source, use the blank function.

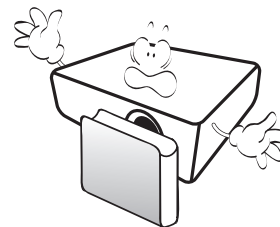

8. Do not operate light source beyond the rated light source life. Excessive operation of light source beyond the rated life could cause them to break on rare occasions.



9. Never replace the light source assembly or any electronic components unless the projector is unplugged.



10. Do not place this product on an unstable cart, stand, or table. The product may fall, sustaining serious damage.



11. Do not attempt to disassemble this projector. There are dangerous high voltages inside which may cause death if you should come into contact with live parts. The only user serviceable part is the light source which has its own removable cover.

Under no circumstances should you ever undo or remove any other covers. Refer servicing only to suitably qualified professional service personnel.



12. Do not block the ventilation holes.

- Do not place this projector on a blanket, bedding or any other soft surface.
- Do not cover this projector with a cloth or any other item.
- Do not place inflammables near the projector.

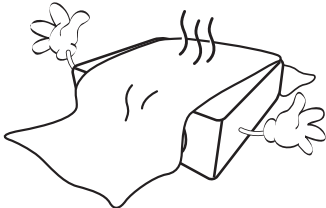

If the ventilation holes are seriously obstructed, overheating inside the projector may result in a fire.

13. Always place the projector on a level, horizontal surface during operation.

- Do not use if tilted at an angle of more than 10 degrees left to right, nor at angle of more than 15 degrees front to back. Using the projector when it is not fully horizontal may cause a malfunction of, or damage to, the light source.

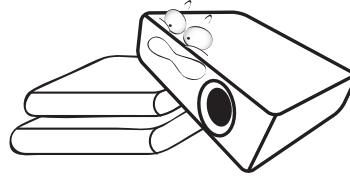

14. Do not stand the projector on end vertically. Doing so may cause the projector to fall over, causing injury or resulting in damage to the projector.

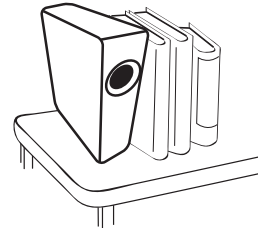

15. Do not step on the projector or place any objects upon it. Besides probable physical damage to the projector, doing so may result in accidents and possible injury.

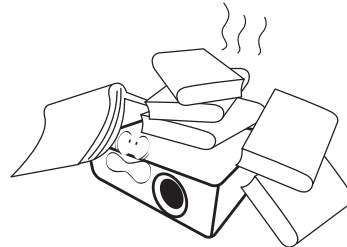

16. When the projector is under operation, you may sense some heated air and odor from its ventilation grill. It is a normal phenomenon and not a product defect.

17. Do not place liquids near or on the projector. Liquids spilled into the projector may cause it to fail. If the projector does become wet, disconnect it from the power supply's power outlet and call BenQ to have the projector serviced.

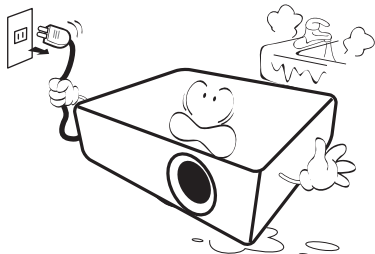

18. This product is capable of displaying inverted images for ceiling/wall mount installation.

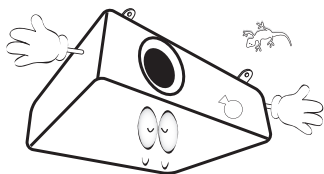

19. This apparatus must be earthed.

20. Do not place this projector in any of the following environments.

- Space that is poorly ventilated or confined. Allow at least 50 cm clearance from walls and free flow of air around the projector.
- Locations where temperatures may become excessively high, such as the inside of a car with all windows rolled up.
- Locations where excessive humidity, dust, or cigarette smoke may contaminate optical components, shorten the projector's life span and darken the image.

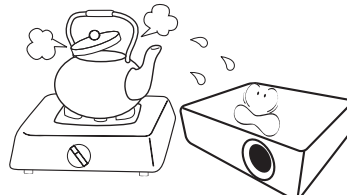

- Locations near fire alarms
- Locations with an ambient temperature above 40°C / 104°F
- Locations where the altitudes are higher than 3000 m (10000 feet).

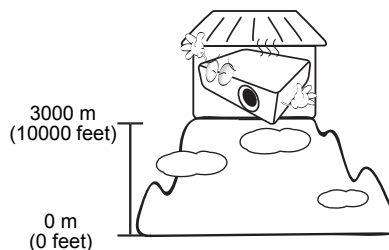

# Introduction

## Shipping contents

Carefully unpack and verify that you have all of the items shown below. If any of these items are missing, please contact your place of purchase.

### Standard accessories

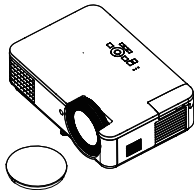

Projector



Remote control with batteries



User manual CD



Quick Start Guide



Warranty card\*

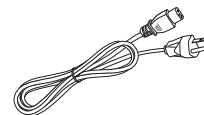

Power cord

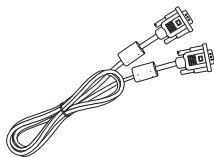

VGA cable



• The supplied accessories will be suitable for your region, and may differ from those illustrated.

• \*The warranty card is only supplied in some specific regions. Please consult your dealer for detailed information.

### Optional accessories

1. 3D glasses
2. Dust filter
3. QCast
4. QCast Mirror

### Replacing the remote control batteries

1. Press and open the battery cover, as illustrated.
2. Remove the old batteries (if applicable) and install two AAA batteries. Make sure that the positive and negative ends are positioned correctly, as illustrated.
3. Replace the battery cover until it clicks into place.

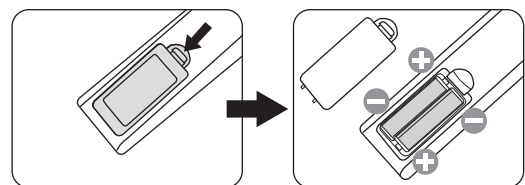



- Avoid leaving the remote control and batteries in an excessive heat or humid environment like the kitchen, bathroom, sauna, sunroom or in a closed car.
- Replace only with the same or equivalent type recommended by the battery manufacturer.
- Dispose of the used batteries according to the manufacturer's instructions and local environment regulations for your region.
- Never throw the batteries into a fire. There may be danger of an explosion.
- If the batteries are dead or if you will not be using the remote control for an extended period of time, remove the batteries to avoid damage to the remote control from possible battery leakage.

## Projector exterior view

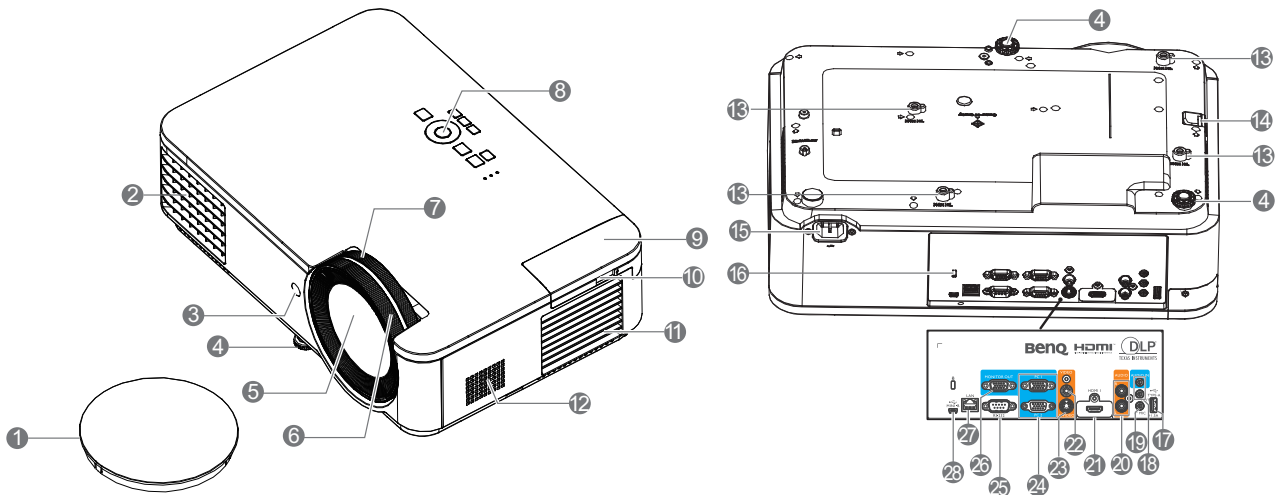

- |   |  |
|---|--|
| <ol style="list-style-type: none"> <li>1. Lens cover</li> <li>2. Vent (air exhaust)</li> <li>3. IR remote sensor</li> <li>4. Adjuster feet</li> <li>5. Projection lens</li> <li>6. Focus ring</li> <li>7. Zoom ring</li> <li>8. External control panel<br/>(See <a href="#">Controls and functions on page 9.</a>)</li> <li>9. QCast (HDMI 2/MHL-input port for HDMI dongle<sup>a</sup>)</li> <li>10. USB cable (A to Micro B type) connect to the power port of HDMI wireless dongle</li> <li>11. Vent (air inlet)</li> <li>12. Speaker</li> <li>13. Wall mount holes</li> <li>14. Security bar</li> <li>a. QCast/ QCast Mirror HDMI dongle</li> </ol> | <ol style="list-style-type: none"> <li>15. AC power jack</li> <li>16. Kensington anti-theft lock slot</li> <li>17. USB Type A port</li> <li>18. Audio input jack<br/>Audio output jac</li> <li>19. Microphone</li> <li>20. Audio (L/R) input jack</li> <li>21. HDMI I input port</li> <li>22. Video input jack</li> <li>23. S-Video input jack</li> <li>24. RGB (PC) signal input jack</li> <li>25. RS-232 control port</li> <li>26. RGB (PC) signal output jack</li> <li>27. RJ-45 LAN input jack</li> <li>28. USB Mini-B port</li> </ol> |
|---|--|



# Controls and functions

## Projector & Remote control



All the key presses described in this document are available on the remote control or projector.

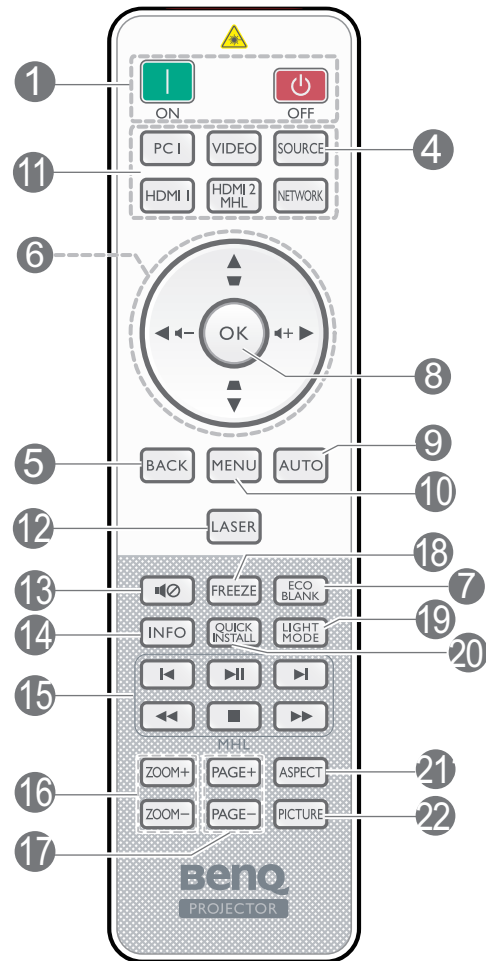
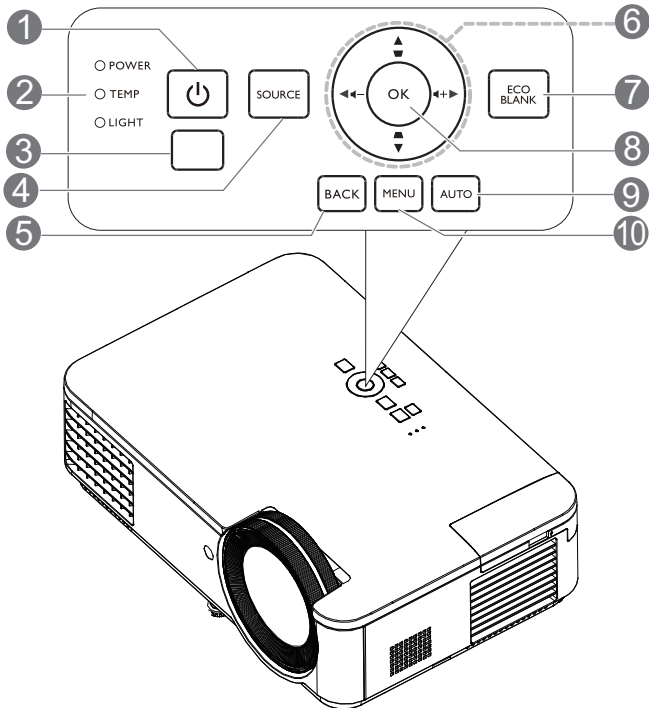

### 1. **POWER**

Toggles the projector between standby mode and on.



Toggles the projector between standby mode and on.

### 2. **POWER indicator light/TEMPerature warning light/LIGHT indicator light** (See [Indicators on page 42.](#))

3. IR remote sensor

### 4. **SOURCE**

Displays the source selection bar.

### 5. **BACK**

Goes back to previous OSD menu, exits and saves menu settings.

### 6. Arrow keys (▲, ▼, ◀, ▶)

When the On-Screen Display (OSD) menu is activated, these keys are used as directional arrows to select the desired menu items and to make adjustments.

Keystone keys (△, ▽)

Displays the keystone correction page.

Volume keys ◀- / ▶+

Decreases or increase the projector volume.

### 7. **ECO BLANK**

Used to hide the screen picture.



Do not block the projection lens from projecting as this could cause the blocking object to become heated and deformed or even cause a fire.

8. **OK**  
Confirms the selected On-Screen Display (OSD) menu item.
9. **AUTO**  
Automatically determines the best picture timings for the displayed image when PC signal (analog RGB) is selected.
10. **MENU**  
Turns on the On-Screen Display (OSD) menu.
11. Source selection button: **PC 1/HDMI 1/VIDEO/HDMI 2/MHL/NETWORK**  
Selects **PC 1/HDMI 1/VIDEO/HDMI 2/MHL/NETWORK** input source for display.
12. **LASER**  
Emits visible laser pointer light for presentation purposes.
13.   
Toggles projector audio between on and off.
14. **INFO**  
Displays the projector information.
15. **MHL**  
Operates for MHL function.
16. **ZOOM+/ZOOM-**  
Magnifies or reduces the projected picture size.
17. **PAGE+/PAGE-**  
Operate your display software program (on a connected PC) which responds to page up/down commands (like Microsoft PowerPoint).
18. **FREEZE**  
Freezes the projected image.
19. **LIGHT MODE**  
Displays the **Light Mode** menu for selecting a suitable light operating mode.
20. **QUICK INSTALL**  
Quickly selects several functions to adjust the projected image and displays the test pattern.
21. **ASPECT**  
Selects the display aspect ratio.
22. **PICTURE**  
Selects the picture mode.

## Controlling your smart device with the remote control

When the projector projects the content from your MHL compatible smart device, you can use the remote control to control your smart device.

To enter the MHL mode, press and hold **AUTO** for 3 seconds. The following buttons are available for controlling your smart device: **Arrow keys** (**▲**, **▼**, **◀**, **▶**), **MENU**, **BACK**, **OK**.

To leave the MHL mode, press and hold **AUTO** for 3 seconds.

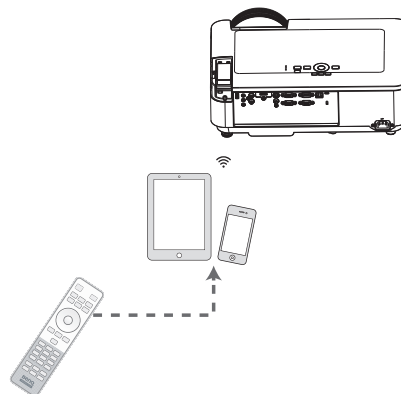

When the projector is under MHL mode, the keypad on the projector should be with the same definition of the keys on the remote control.

## Remote control effective range

The remote control must be held at an angle within 30 degrees perpendicular to the projector's IR remote control sensor(s) to function correctly. The distance between the remote control and the sensor(s) should not exceed 8 meters (~ 26 feet).

Make sure that there are no obstacles between the remote control and the IR sensor(s) on the projector that might obstruct the infra-red beam.

- Operating the projector from the front

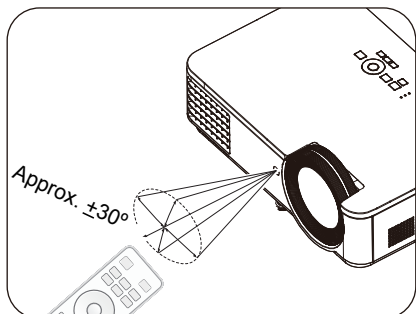

- Operating the projector from the top

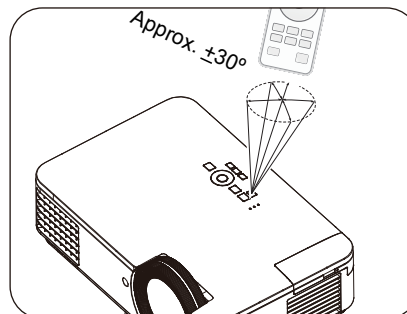

# Positioning your projector

## Choosing a location

Before choosing an installation location for your projector, take the following factors into consideration:

- Size and position of your screen
- Electrical outlet location
- Location and distance between the projector and the rest of your equipment

You can install your projector in the following ways.

---

### 1. Front Table

Select this location with the projector placed on the table in front of the screen. This is the most common way to position the projector for quick setup and portability.

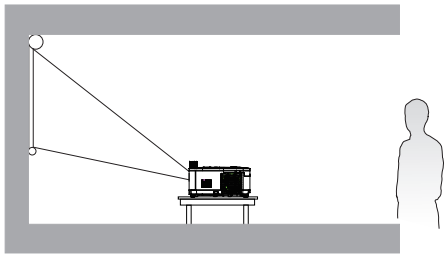

### 2. Rear Table

Select this location with the projector placed on the table behind the screen. Note that a special rear projection screen is required.

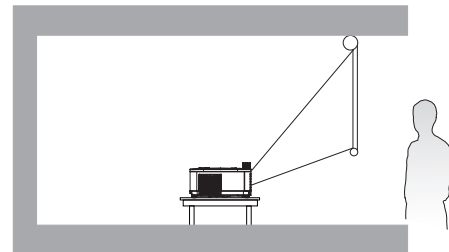

### 3. Front Ceiling

Select this location with the projector suspended upside-down in front of the screen. Purchase the BenQ Projector Ceiling/Wall Mount Kit from your dealer to mount your projector.

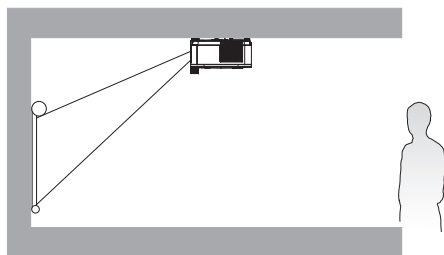

### 4. Rear Ceiling

Select this location with the projector suspended upside-down from behind the screen. Note that a special rear projection screen and the BenQ Projector Ceiling/Wall Mount Kit are required for this installation location.

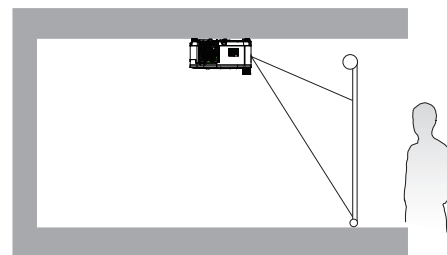

---

After turning on the projector, go to **Advanced Menu - Settings > Projector Installation > Projector Installation** and press ◀/▶ to select a setting.

You can also use **QUICK INSTALL** on the remote control to access this menu.

## Obtaining a preferred projected image size

The distance from the projector lens to the screen, the zoom setting (if available), and the video format each factors in the projected image size.

### Projection dimensions

#### LX820ST

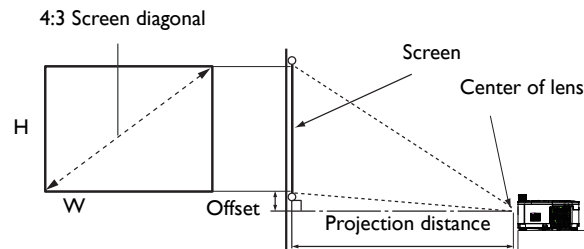

- The screen aspect ratio is 4:3 and the projected picture is in a 4:3 aspect ratio

Screen size			Projection distance (mm)	Offset (mm)	
Diagonal		H (mm)			W (mm)
Inch	mm				
60	1524	914	1219	790	77
70	1778	1067	1422	925	90
75	1905	1143	1524	995	96
80	2032	1219	1626	1060	102
85	2159	1295	1727	1130	109
90	2286	1372	1829	1200	115
95	2413	1448	1930	1265	122
100	2540	1524	2032	1335	128
105	2667	1600	2134	1405	134
110	2794	1676	2235	1472	141
120	3048	1829	2438	1600	154

For example, if you are using a 70-inch screen, the recommended projection distance is 925 mm.

- If your measured projection distance is 1000 mm, the closest match in the "Projection distance (mm)" column is 995 mm. Looking across this row shows that a 75" (about 1.9 m) screen is required.



All measurements are approximate and may vary from the actual sizes.

BenQ recommends that if you intend to permanently install the projector, you should physically test the projection size and distance using the actual projector in situ before you permanently install it, so as to make allowance for this projector's optical characteristics. This will help you determine the exact mounting position so that it best suits your installation location.

# LW820ST

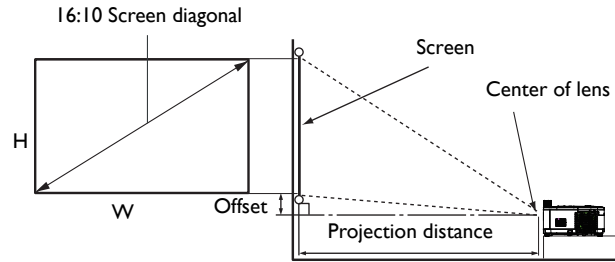

- The screen aspect ratio is 16:10 and the projected picture is in a 16:10 aspect ratio

Screen size				Projection distance (mm)	Offset (mm)
Diagonal		H (mm)	W (mm)		
Inch	mm				
60	1524	808	1292	665	49
70	1778	942	1508	780	57
75	1905	1010	1615	835	62
80	2032	1077	1723	895	66
85	2159	1144	1831	952	70
90	2286	1212	1939	1010	74
95	2413	1279	2046	1070	78
100	2540	1346	2154	1126	82
105	2667	1414	2262	1185	86
110	2794	1481	2369	1245	90
120	3048	1615	2585	1360	99

For example, if you are using a 80-inch screen, the recommended projection distance is 895 mm.

- If your measured projection distance is 1000 mm, the closest match in the "Projection distance (mm)" column is 1010 mm. Looking across this row shows that a 90" (about 2.2 m) screen is required.



All measurements are approximate and may vary from the actual sizes.

BenQ recommends that if you intend to permanently install the projector, you should physically test the projection size and distance using the actual projector in situ before you permanently install it, so as to make allowance for this projector's optical characteristics. This will help you determine the exact mounting position so that it best suits your installation location.

## Mounting the projector

If you intend to mount your projector, we strongly recommend that you use a proper fitting BenQ projector mounting kit and that you ensure it is securely and safely installed.

If you use a non-BenQ brand projector mounting kit, there is a safety risk that the projector may fall down due to an improper attachment through the use of the wrong gauge or length screws.

## Before mounting the projector

- Purchase a BenQ projector mounting kit from the place you purchased your BenQ projector.
- BenQ recommends that you also purchase a separate Kensington lock compatible security cable and attach it securely to both the Kensington lock slot on the projector and the base of the mounting bracket. This will perform the secondary role of restraining the projector should its attachment to the mounting bracket become loose.
- Ask your dealer to install the projector for you. Installing the projector on your own may cause it to fall and result in injury.

- Take necessary procedures to prevent the projector from falling off such as during an earthquake.
- The warranty doesn't cover any product damage caused by mounting the projector with a non-BenQ brand projector mounting kit.
- Consider the surrounding temperature where the projector is ceiling/wall mounted. If a heater is used, the temperature around the ceiling/wall may be higher than expected.
- Read the user manual for the mounting kit about the range of torque. Tightening with torque exceeding the recommended range may cause damage to the projector and subsequently falling off.
- Make sure the power outlet is at an accessible height so that you can easily shut down the projector.

## Ceiling/Wall mount installation diagram

Ceiling/Wall mount screw: M4  
(Max L = 25 mm; Min L = 20 mm)

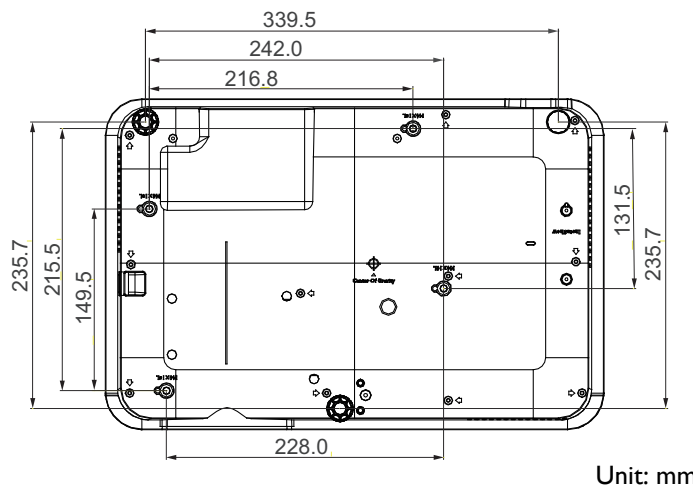

## Adjusting the projected image

### Adjusting the projection angle

If the projector is not placed on a flat surface or the screen and the projector are not perpendicular to each other, the projected image becomes trapezoidal. You can screw the adjuster feet to fine-tune the horizontal angle.

To retract the feet, screw the adjuster feet in a reverse direction.

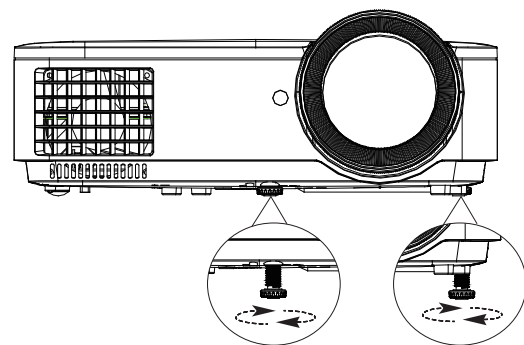

Do not look into the lens while the light source is on. The strong light from the light source may cause damage to your eyes.

## Auto-adjusting the image

In some cases, you may need to optimize the picture quality. To do this, press **AUTO**. Within 3 seconds, the built-in Intelligent Auto Adjustment function will re-adjust the values of Frequency and Clock to provide the best picture quality.

The current source information will be displayed in the corner of the screen for 3 seconds.



This function is only available when PC signal (analog RGB) is selected.

## Fine-tuning the image size and clarity

Adjust the projected image to the size that you need using the zoom ring.

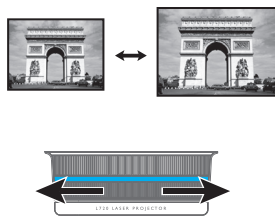

Sharpen the image by rotating the focus ring.

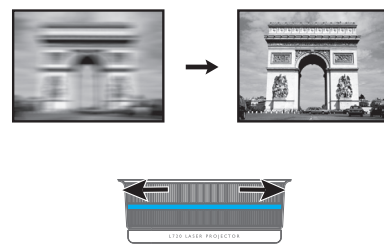

## Correcting keystone

Keystoning refers to the situation where the projected image becomes a trapezoid due to angled projection.

To correct this, you will need to manually correct it following one of these steps.

1. Do one of the following steps to display the 2D keystone correction page.

- Press  $\triangle$  /  $\nabla$  on the projector or remote control.
- Press **QUICK INSTALL** on the remote control. Press  $\blacktriangledown$  to highlight **Keystone** and press **OK**.
- Go to **Advanced Menu - Display > Keystone** and press **OK**.



2. After the **Keystone** correction page displays. Press  $\triangle$  to correct keystone at the top of the image. Press  $\nabla$  to correct keystone at the bottom of the image.



# Connection

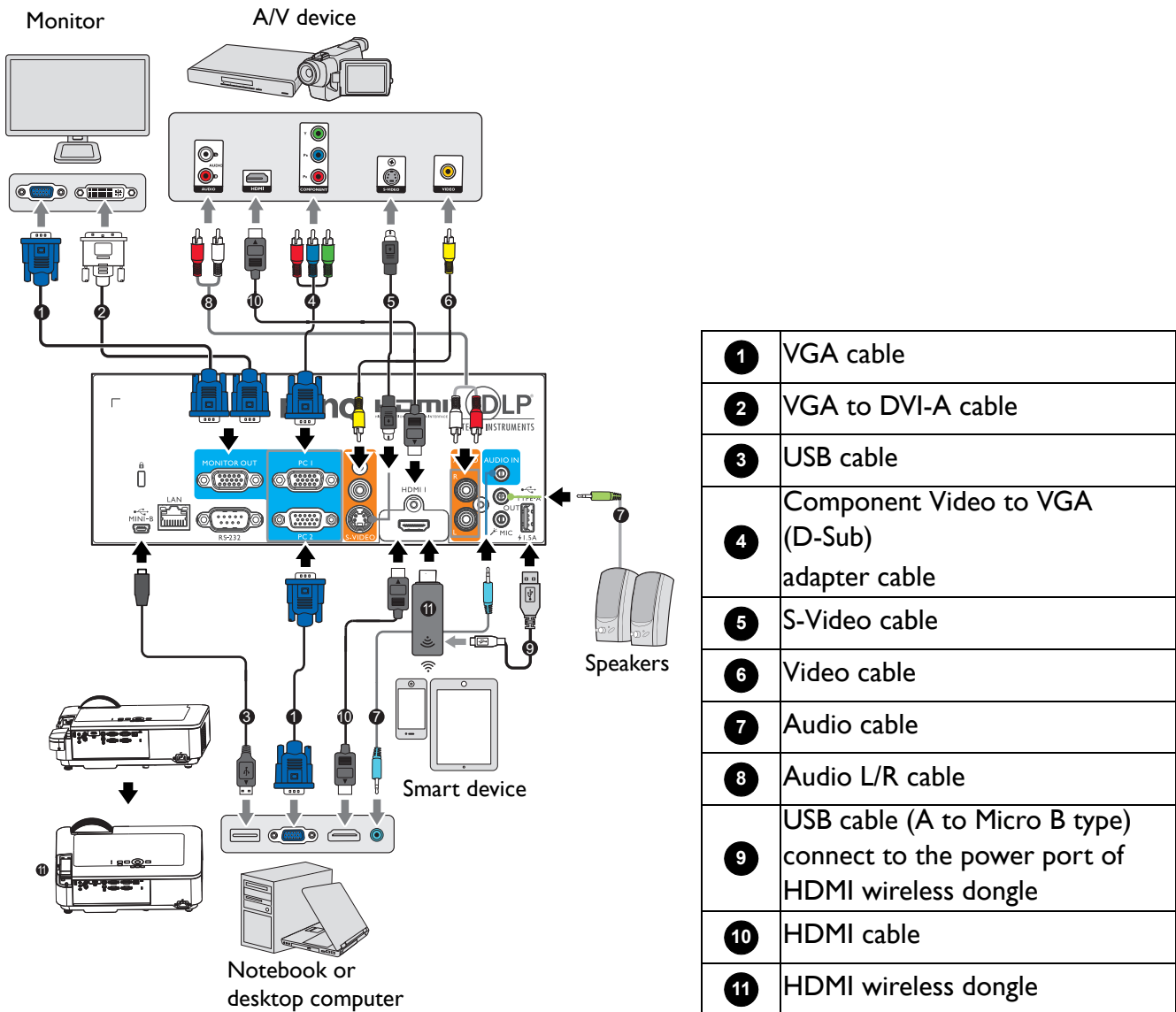

When connecting a signal source to the projector, be sure to:

1. Turn all equipment off before making any connections.
2. Use the correct signal cables for each source.
3. Ensure the cables are firmly inserted.

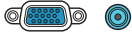

- In the connections above, some cables may not be included with the projector (see [Shipping contents on page 7](#)). They are commercially available from electronics stores.
- The connection illustrations are for reference only. The rear connecting jacks available on the projector vary with each projector model.
- Many notebooks do not turn on their external video ports when connected to a projector. Usually a key combo like FN + function key with a monitor symbol turns the external display on/off. Press FN and the labeled function key simultaneously. Refer to your notebook's documentation to find your notebook's key combination.
- If the selected video image is not displayed after the projector is turned on and the correct video source has been selected, check that the video source device is turned on and operating correctly. Also check that the signal cables have been connected correctly.

You need only connect the projector to a video source device using just one of the connecting methods, however each provides a different level of video quality.

Terminal		Picture quality
<b>HDMI/MHL</b>		Best
<b>Component Video (through RGB input)</b>		Better
<b>S-Video</b>		Good
<b>Video</b>		Normal

## Connecting audio

The projector has built-in mono speaker(s) which are designed to provide basic audio functionality accompanying data presentations for business purposes only. They are not designed for, nor intended for stereo audio reproduction use as might be expected in home theater or home cinema applications. Any stereo audio input (if provided), is mixed into a common mono audio output through the projector speaker(s).

The built-in speaker(s) will be muted when the **AUDIO OUT** jack is connected.



- The projector is only capable of playing mixed mono audio, even if a stereo audio input is connected.
- If the selected video image is not displayed after the projector is turned on and the correct video source has been selected, check that the video source device is turned on and operating correctly. Also check that the signal cables have been connected correctly.

## Connecting smart devices

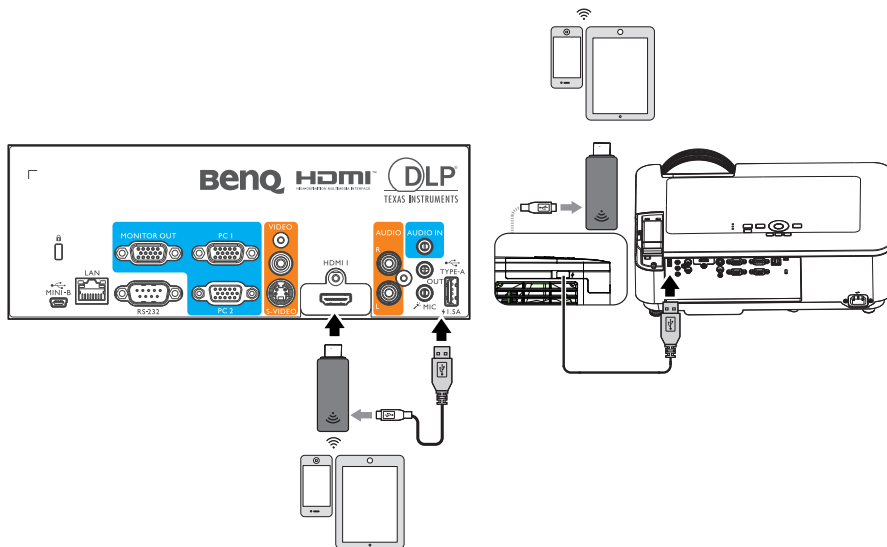

The projector can project the content directly from a smart device by using a wireless dongle.  
HDMI wireless dongle (e.g. BenQ QCastMirror, QCast)



- Connect the dongle to **HDMI I** and **TYPE-A** ports on the projector and switch the input signal to **HDMI-I**.

# Operation

## Starting up the projector





1. Plug the power cord. Turn on the power outlet switch (where fitted). The power indicator on the projector lights orange after power has been applied.
2. Press  on the projector or  on the remote control to start the projector. The power indicator flashes green and stays green when the projector is on. The start up procedure takes about 30 seconds. In the later stage of start up, a startup logo is projected.

(If necessary) Rotate the focus ring to adjust the image clearness.

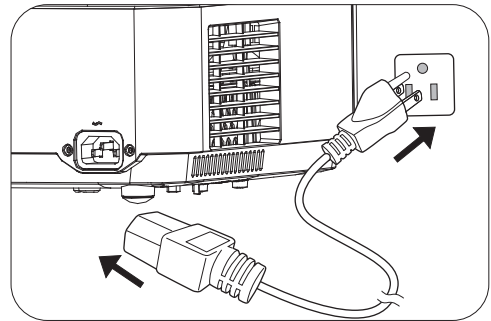
3. If the projector is activated for the first time, select your OSD language following the on-screen instructions.
4. If you are prompted for a password, press the arrow keys to enter a 6-digit password. See [Utilizing the password function on page 23](#).
5. Switch all of the connected equipment on.
6. The projector will search for input signals. The current input signal being scanned appears. If the projector does not detect a valid signal, the message “No Signal” will continue displaying until an input signal is found.

You can also press **SOURCE** to select your desired input signal. See [Switching input signal on page 24](#).



-  • Please use the original accessories (e.g. power cord) to avoid possible dangers such as electric shock and fire.
  -  • If the projector is still hot from previous activity, it will run the cooling fan for approximately 90 seconds before energizing the light source.
- 
-  • The Setup Wizard screenshots are for reference only and may differ from the actual design.
  -  • If the frequency/resolution of the input signal exceeds the projector's operating range, you will see the message “Out of Range” displayed on the background screen. Please change to an input signal which is compatible with the projector's resolution or set the input signal to a lower setting. See [Timing chart on page 46](#).
  -  • If no signal is detected for 3 minutes, the projector automatically enters saving mode.

# Using the menus

The projector is equipped with 2 types of On-Screen Display (OSD) menus for making various adjustments and settings.

- **Basic** OSD menu: provides primary menu functions. (See [Basic menu on page 30](#))
- **Advanced** OSD menu: provides full menu functions. (See [Advanced menu on page 32](#))

To access the OSD menu, press **MENU** on the projector or remote control.

- Use the arrow keys (▲/▼/◀/▶) on the projector or remote control to move through the menu items.
- Use **OK** on the projector or remote control to confirm the selected menu item.

The first time you use the projector (after finishing the initial setup), Basic OSD menu displays.



The OSD screenshots below are for reference only, and may differ from the actual design.

Below is the overview of the **Basic** OSD menu.

	1	Menu Type	4	Press <b>OK</b> to enter the menu.
	2	Main menu	5	Status
	3	Current input signal	6	Press <b>MENU</b> to go to the previous page or to exit.

If you intend to switch from the **Basic** OSD menu to the **Advanced** OSD menu, follow the instructions below:

1. Go to **Basic Menu > Menu Type**.
2. Press **OK** and press ▲/▼ to select **Advanced**. Next time when you turn on the projector, you may access the **Advanced** OSD menu by pressing **MENU**.

Below is the overview of the **Advanced** OSD menu.

	1	Main menu & Main menu icon	5	Press <b>BACK</b> to go to the previous page.
	2	Sub-menu	6	Press <b>MENU</b> to go to the previous page or to exit.
	3	Current input signal	7	Status
	4	Press <b>OK</b> to enter the menu.		

Likewise, when you wish to switch from the **Advanced** OSD menu to the **Basic** OSD menu, follow the instructions below:

1. Go to **Advanced Menu - System > Menu Settings** and press **OK**.
2. Select **Menu Type** and **OK**.
3. Press **▲/▼** to select **Basic**. Next time when you turn on the projector, you may access the **Basic** OSD menu by pressing **MENU**.

# Securing the projector

## Using a security cable lock

The projector has to be installed in a safe place to prevent theft. Otherwise, purchase a lock, such as the Kensington lock, to secure the projector. You can locate a Kensington lock slot on the rear side of the projector. See item 16 on [page 8](#).

A Kensington security cable lock is usually a combination of key(s) and the lock. Refer to the lock's documentation for finding out how to use it.

## Utilizing the password function

### Setting a password

1. Go to **Advanced Menu - Settings > Security Settings**. Press **OK**. The **Security Settings** page appears.
2. Highlight **Change Password** and press **OK**.
3. The four arrow keys (**▲**, **▶**, **▼**, **◀**) respectively represent 4 digits (1, 2, 3, 4). According to the password you desire to set, press the arrow keys to enter six digits for the password.
4. Confirm the new password by re-entering the new password.  
Once the password is set, the OSD menu returns to the **Security Settings** page.
5. To activate the **Power On Lock** function, press **▲/▼** to highlight **Power On Lock** and press **◀/▶** to select **On**. Input the password again.

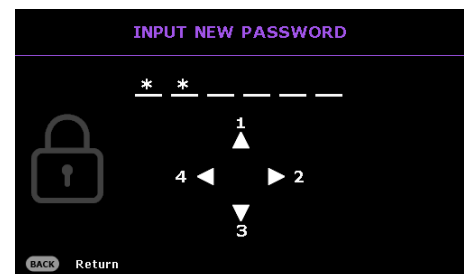

- The digits being input will display as asterisks on-screen. Make a note of your selected password and keep it in a safe place in advance or right after the password is entered so that it is available to you should you ever forget it.
- Once a password has been set and the power on lock is activated, the projector cannot be used unless the correct password is entered every time the projector is started.

### If you forget the password

If you enter the wrong password, the password error message will appear, and the **Input Current Password** message follows. If you absolutely do not remember the password, you can use the password recall procedure. See [Entering the password recall procedure on page 23](#).

If you enter an incorrect password 5 times in succession, the projector will automatically shut down in a short time.

### Entering the password recall procedure

1. Press and hold **AUTO** for 3 seconds. The projector will display a coded number on the screen.
2. Write down the number and turn off your projector.
3. Seek help from the local BenQ service center to decode the number. You may be required to provide proof of purchase documentation to verify that you are an authorized user of the projector.

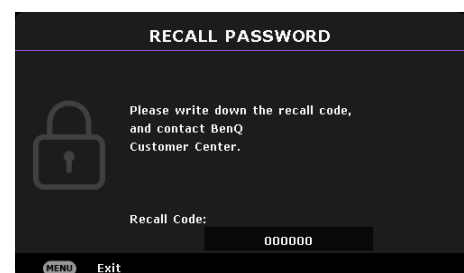
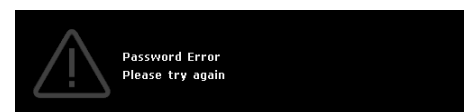

## Changing the password

1. Go to **Advanced Menu - Settings > Security Settings > Change Password**.
2. Press **OK**. The message “**Input Current Password**” appears.
3. Enter the old password.
  - If the password is correct, another message “**Input New Password**” appears.
  - If the password is incorrect, the password error message will appear, and the message “**Input Current Password**” appears for your retry. You can press **BACK** to cancel the change or try another password.
4. Enter a new password.
5. Confirm the new password by re-entering the new password.

## Disabling the password function

To disable password protection, go to **Advanced Menu - Settings > Security Settings > Power On Lock** and press **◀/▶** to select **Off**. The message “**Input Current Password**” appears. Enter the current password.

- If the password is correct, the OSD menu returns to the **Security Settings** page. You will not have to enter the password next time turning on the projector.
- If the password is incorrect, the password error message will appear, and the message “**Input Current Password**” appears for your retry. You can press **BACK** to cancel the change or try another password.



Though the password function is disabled, you need to keep the old password in hand should you ever need to re-activate the password function by entering the old password.

## Switching input signal

The projector can be connected to multiple devices at the same time. However, it can only display one full screen at a time. When starting up, the projector automatically searches for the available signals.

Be sure the **Advanced Menu - Settings > Auto Source Search** menu is **On** if you want the projector to automatically search for the signals.

To select the source:

1. Press **SOURCE**. A source selection bar appears.
2. Press **▲/▼** until your desired signal is selected and press **OK**.

Once detected, the selected source information will appear at the corner of the screen for seconds. If there is multiple equipment connected to the projector, repeat steps 1-2 to search for another signal.



- The brightness level of the projected image will change accordingly when you switch between different input signals.
- For best display picture results, you should select and use an input signal which outputs at the projector's native resolution. Any other resolutions will be scaled by the projector depending upon the “aspect ratio” setting, which may cause some image distortion or loss of picture clarity. See [Aspect Ratio on page 30](#).



## Controlling the projector via LAN

Wired LAN allows you to manage the projector from a computer using a web browser when the computer and the projector are properly connected to the same local area network.

### Configuring the Wired LAN Settings

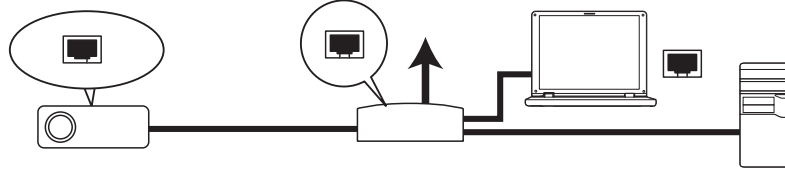

#### If you are in a DHCP environment:

1. Take a RJ45 cable and connect one end to the LAN input jack of the projector and the other end to the RJ45 port.



• When connecting the RJ45 cable, avoid coiling and intertwining the cable as it may cause signal noise or interruption.

2. Go to **Advanced Menu - Network > Wired LAN**. Press **OK**. The **Wired LAN** page appears.
3. Press **▼** to select **DHCP** and press **◀/▶** to select **On**.
4. Please wait for around 15 - 20 seconds, and then re-enter the **Wired LAN** page.
5. The **IP Address**, **Subnet Mask**, **Default Gateway**, and **DNS Server** settings will be displayed. Note down the IP address displayed in the **IP Address** row.



• If the IP Address still does not display, contact your ITS administrator.

6. Go back to **Advanced Menu - Network > Wired LAN** page.
7. Press **▼** to highlight **AMX Device Discovery** and press **◀/▶** to select **On** or **Off**. When **AMX Device Discovery** is **On**, the projector can be detected by AMX controller.

#### If you are in a non-DHCP environment:

1. Go to **Advanced Menu - Network > Wired LAN** page.
2. Press **▼** to select **DHCP** and press **◀/▶** to select **Off**.
3. Contact your ITS administrator for information on the **IP Address**, **Subnet Mask**, **Default Gateway**, and **DNS Server** settings.
4. Press **▼** to select the item you want to modify and press **OK**.
5. Press **◀/▶** to move the cursor and then press **▲/▼** to enter the value.
6. To save the setting, press **OK**. If you do not want to save the setting, press **BACK**.
7. Press **▼** to highlight **Apply** and press **OK**.
8. Go back to **Advanced Menu - Network > Wired LAN** page., press **▼** to highlight **AMX Device Discovery** and press **◀/▶** to select **On** or **Off**.
9. Press **MENU** to exit the menu.

## Upgrading firmware via LAN

The BenQ Easy Firmware Updater is a software program that enables remote and centralized upgrade the BenQ network projector on a host computer.

The key features of the BenQ Easy Firmware Updater include:

- Search for projectors in the different subnet.
- Support multiple projectors firmware upgrade at the same time (up to 255).

For more information about the tool, please contact BenQ service.

## Controlling the projector remotely via a web browser

Once you have the correct IP address for the projector and the projector is on or in standby mode, you can use any computer that is on the same local area network to control the projector.

1. Enter the address of the projector in the address bar of your browser and click Go.



2. The remote network operation page opens. This page (Crestron eControl) allows you to operate the projector as if you were using the remote control or control panel on the projector.



1.	<p>To switch input source, click on your desired signal.</p>  <p>The source list varies according to the connectors available on the projector. "Video" stands for the Video signal.</p>
----	---

2.	Menu Auto PC Blank Input ▲ (△) ▼ (▽) ◀ (◁) ▶ (▷)	See <a href="#">Projector &amp; Remote control on page 9</a> for details.
	OK	Activates the selected On-Screen Display (OSD) menu item.

The tools page allows you to manage the projector, configure the LAN control settings and secure access of remote network operation on this projector.

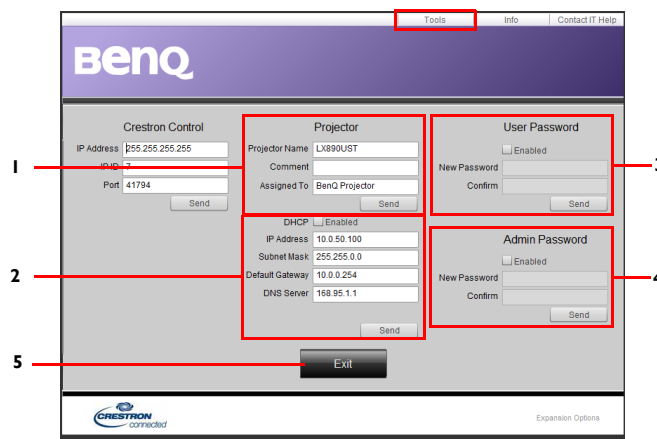

1. You can name the projector, keep track of its location and the person in charge of it.
2. You can adjust the **LAN Control Settings**.
3. Once set, access to the remote network operation on this projector has been password protected.
4. Once set, access to the tools page has been password-protected.
5. Press **Exit** to go back to the remote network operation page.



After making the adjustments, press the Send button and the data will be saved in the projector

Please pay attention to the limitation of input length (including space and other punctuation keys) in the list below:

Category item	Input length	Maximum number of characters
Crestron Control	IP Address	15
	IP ID	4
	Port	5
Projector	Projector Name	22
	Location	22
	Assigned To	(N/A)
Network Configuration	DHCP (Enabled)	15
	IP Address	15
	Subnet Mask	15
	Default Gateway	15
	DNS Server	(N/A)
User Password	Enabled	(N/A)
	New Password	15
	Confirm	15
Admin Password	Enabled	(N/A)
	New Password	15
	Confirm	15



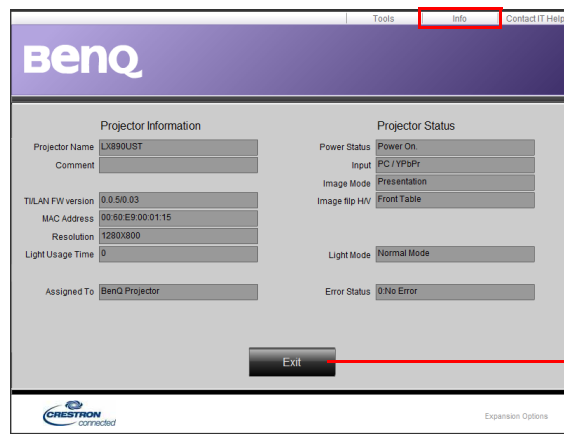

The info page displays the information and status of this projector.



Press **Exit** to go back to the remote network

For more information, visit <http://www.crestron.com> & [www.crestron.com/getroomview](http://www.crestron.com/getroomview).

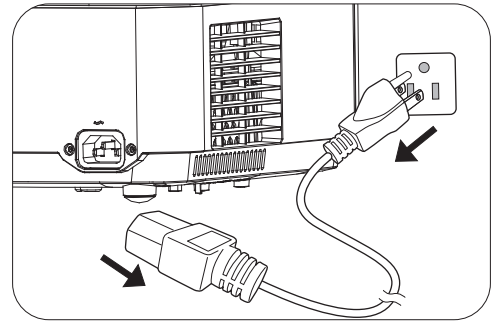

## Shutting down the projector

1. Press  on the projector or  on the remote control and a confirmation message will appear prompting you. If you don't respond in a few seconds, the message will disappear.
2. Press  or  a second time. The power indicator flashes orange, the projection light source shuts down, and the fans will continue to run for approximately 90 seconds to cool down the projector.
3. Once the cooling process finishes, the power indicator becomes a steady orange and fans stop. Disconnect the power cord from the power outlet.



- To protect the light source, the projector will not respond to any commands during the cooling process.
- Avoid turning on the projector immediately after turning it off as excessive heat may shorten light source life.
- Light source life results will vary depending on environmental conditions and usage.

## Direct power off

The AC power cord can be pulled out right after the projector is turned off. To protect the light source, wait about 10 minutes before re-starting the projector. If you attempt to re-start the projector, the fans may run for a few minutes to cool down. In such cases, press  or  again to start the projector after the fans stop and the power indicator turns orange.

# Menu operation

Please note that the on-screen display (OSD) menus vary according to the signal type selected and the projector model you are using.

The menu items are available when the projector detects at least one valid signal. If there is no equipment connected to the projector or no signal detected, limited menu items are accessible.

## Basic menu

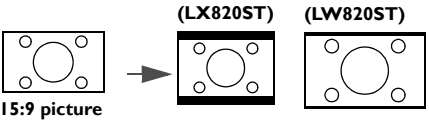
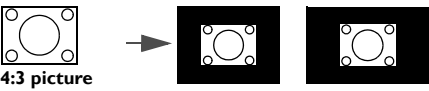
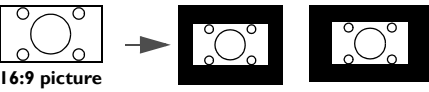
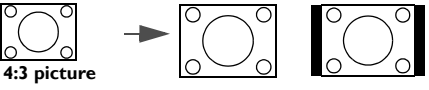
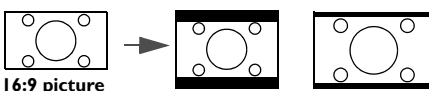
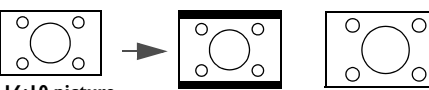
<p><b>Brightness</b></p>	<p>The higher the value, the brighter the image. Adjust this control so the black areas of the image appear just as black and that detail in the dark areas is visible.</p>
<p><b>Aspect Ratio</b></p>	<p>There are several options to set the image's aspect ratio depending on your input signal source.</p> <ul style="list-style-type: none"> <li> <p>• <b>Auto:</b> Scales an image proportionally to fit the projector's native resolution in its horizontal or vertical width.</p>  </li> <li> <p>• <b>Real:</b> Projects an image as its original resolution and resizes it to fit within the display area. For input signals with lower resolutions, the projected image will be displayed in its original size.</p>   </li> <li> <p>• <b>4:3:</b> Scales an image so that it is displayed in the center of the screen with a 4:3 aspect ratio.</p>  </li> <li> <p>• <b>16:9:</b> Scales an image so that it is displayed in the center of the screen with a 16:9 aspect ratio.</p>  </li> <li> <p>• <b>16:10:</b> Scales an image so that it is displayed in the center of the screen with a 16:10 aspect ratio.</p>  </li> </ul>

<p><b>Picture Mode</b></p>	<p>The projector is preset with several predefined picture modes so that you can choose one to suit your operating environment and input signal picture type.</p> <ul style="list-style-type: none"> <li>• <b>Bright:</b> Maximizes the brightness of the projected image. This mode is suitable for environments where extra-high brightness is required, such as using the projector in well lit rooms.</li> <li>• <b>Presentation:</b> Is designed for presentations. The brightness is emphasized in this mode to match PC and notebook coloring.</li> <li>• <b>sRGB:</b> Maximizes the purity of RGB colors to provide true-to-life images regardless of brightness setting. It is most suitable for viewing photos taken with an sRGB compatible and properly calibrated camera, and for viewing PC graphic and drawing applications such as AutoCAD.</li> <li>• <b>Cinema:</b> Is appropriate for playing colorful movies, video clips from digital cameras or DVs through the PC input for best viewing in a blackened (little light) environment.</li> <li>• <b>Vivid:</b> This is suitable for displaying colorful video and pictures with well-balanced color saturation and high color brightness.</li> <li>• <b>Infographic:</b> Is perfect for presentations with the mixture of text and graphics due to its high color brightness and better color gradation to see the details clearly.</li> <li>• <b>3D:</b> Is appropriate for playing 3D images and 3D video clips.</li> <li>• <b>User 1/User 2:</b> Recalls the settings customized based on the current available picture modes. See <a href="#">Reference Mode on page 32</a>.</li> </ul>
<p><b>Volume</b></p>	<p>Adjusts the sound level.</p>
<p><b>Light Mode</b></p>	<p>See <a href="#">Setting the Light Mode on page 41</a>.</p>
<p><b>Information</b></p>	<ul style="list-style-type: none"> <li>• <b>Native Resolution:</b> Shows the native resolution of the projector.</li> <li>• <b>Detected Resolution:</b> Shows the native resolution of the input signal.</li> <li>• <b>Source:</b> Shows the current signal source.</li> <li>• <b>Picture Mode:</b> Shows the selected mode in the <b>Picture</b> menu.</li> <li>• <b>Light Mode:</b> Shows the selected mode in the <b>Light Settings</b> menu.</li> <li>• <b>3D Format:</b> Shows the current 3D mode.</li> <li>• <b>Color System:</b> Shows input system format.</li> <li>• <b>Light Usage Time:</b> Shows the number of hours the light source has been used.</li> <li>• <b>Filter Usage Time:</b> Displays the number of hours the filter has been used.</li> <li>• <b>Firmware Version:</b> Shows the firmware version of your projector.</li> </ul>
<p><b>Menu Type</b></p>	<p>Switches to the <b>Advanced</b> OSD menu. See <a href="#">Using the menus on page 21</a>.</p>

# Advanced menu

## Picture





<p><b>Picture Mode</b></p>	<p>The projector is preset with several predefined picture modes so that you can choose one to suit your operating environment and input signal picture type.</p> <ul style="list-style-type: none"> <li>• <b>Bright:</b> Maximizes the brightness of the projected image. This mode is suitable for environments where extra-high brightness is required, such as using the projector in well lit rooms.</li> <li>• <b>Presentation:</b> Is designed for presentations. The brightness is emphasized in this mode to match PC and notebook coloring.</li> <li>• <b>sRGB:</b> Maximizes the purity of RGB colors to provide true-to-life images regardless of brightness setting. It is most suitable for viewing photos taken with an sRGB compatible and properly calibrated camera, and for viewing PC graphic and drawing applications such as AutoCAD.</li> <li>• <b>Cinema:</b> Is appropriate for playing colorful movies, video clips from digital cameras or DVs through the PC input for best viewing in a blackened (little light) environment.</li> <li>• <b>Vivid:</b> This is suitable for displaying colorful video and pictures with well-balanced color saturation and high color brightness.</li> <li>• <b>Infographic:</b> Is perfect for presentations with the mixture of text and graphics due to its high color brightness and better color gradation to see the details clearly.</li> <li>• <b>3D:</b> Is appropriate for playing 3D images and 3D video clips.</li> <li>• <b>User 1/User 2:</b> Recalls the settings customized based on the current available picture modes. See <a href="#">Reference Mode on page 32</a>.</li> </ul>
<p><b>Reference Mode</b></p>	<p>There are 2 user-definable modes if the current available picture modes are not suitable for your need. You can use one of the picture modes (except the <b>User 1/User 2</b>) as a starting point and customize the settings.</p> <ol style="list-style-type: none"> <li>1. Go to <b>Picture &gt; Picture Mode</b>.</li> <li>2. Press ◀/▶ to select <b>User 1</b> or <b>User 2</b>.</li> <li>3. Press ▼ to highlight <b>Reference Mode</b>, and press ◀/▶ to select a picture mode that is closest to your need.</li> <li>4. Press ▼ to select a menu item to be changed and adjust the value. The adjustments define the selected user mode.</li> </ol>
<p><b>Brightness</b></p>	<p>The higher the value, the brighter the image. Adjust this control so the black areas of the image appear just as black and that detail in the dark areas is visible.</p>
<p><b>Contrast</b></p>	<p>The higher the value, the greater the contrast. Use this to set the peak white level after you have previously adjusted the Brightness setting to suit your selected input and viewing environment.</p>
<p><b>Color</b></p>	<p>Lower setting produces less saturated colors. If the setting is too high, colors on the image will be overpowering, which makes the image unrealistic.</p>
<p><b>Tint</b></p>	<p>The higher the value, the more greenish the picture becomes. The lower the value, the more reddish the picture becomes.</p>



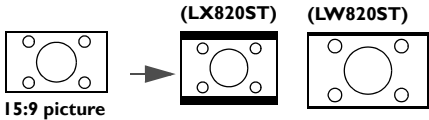

<b>Sharpness</b>	The higher the value, the sharper the picture becomes.
<b>Brilliant Color</b>	<p>This feature utilizes a new color-processing algorithm and system level enhancements to enable higher brightness while providing truer, more vibrant colors in picture. It enables a greater than 50% brightness increase in mid-tone images, which are common in video and natural scenes, so the projector reproduces images in realistic and true colors. If you prefer images with that quality, select <b>On</b>.</p> <p>When <b>Off</b> is selected, the <b>Color Temperature</b> function is not available.</p>
<b>Advanced Color Settings</b>	<p><b>Color Temperature</b></p> <p>There are several preset color temperature settings available. The available settings may vary according to the signal type selected.</p> <ul style="list-style-type: none"> <li>• <b>Normal:</b> Maintains normal colorings for white.</li> <li>• <b>Cool:</b> Makes images appear bluish white.</li> <li>• <b>Warm:</b> Makes images appear reddish white.</li> </ul>
	<p><b>Color Temperature Tuning</b></p> <p>You can also set a preferred color temperature by adjusting the following options.</p> <ul style="list-style-type: none"> <li>• <b>R Gain/G Gain/B Gain:</b> Adjusts the contrast levels of Red, Green, and Blue.</li> <li>• <b>R Offset/G Offset/B Offset:</b> Adjusts the brightness levels of Red, Green, and Blue.</li> </ul>
	<p><b>Color Management</b></p> <p>This function provides six sets (RGBCMY) of colors to be adjusted. When you select each color, you can independently adjust its range and saturation according to your preference.</p> <ul style="list-style-type: none"> <li>• <b>Primary Color:</b> Selects a color from among <b>R</b> (Red), <b>G</b> (Green), <b>B</b> (Blue), <b>C</b> (Cyan), <b>M</b> (Magenta), or <b>Y</b> (Yellow).</li> <li>• <b>Hue:</b> Increase in the range will include colors consisted of more proportions of its two adjacent colors. Please refer to the illustration for how the colors relate to each other. For example, if you select Red and set its range at 0, only pure red in the projected picture will be selected. Increasing its range will include red close to yellow and red close to magenta.</li> <li>• <b>Saturation:</b> Adjusts the values to your preference. Every adjustment made will reflect to the image immediately. For example, if you select Red and set its value at 0, only the saturation of pure red will be affected.</li> </ul> <div data-bbox="1098 1272 1453 1608" data-label="Diagram"> </div> <p> <b>Saturation</b> is the amount of that color in a video picture. Lower settings produce less saturated colors; a setting of “0” removes that color from the image entirely. If the saturation is too high, that color will be overpowering and unrealistic.</p> <ul style="list-style-type: none"> <li>• <b>Gain:</b> Adjusts the values to your preference. The contrast level of the primary color you select will be affected. Every adjustment made will reflect to the image immediately.</li> </ul>

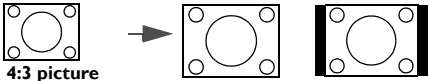
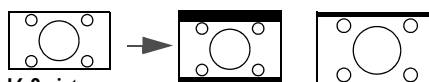
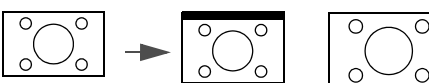
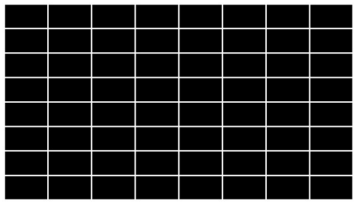
<p><b>Advanced Color Settings</b></p>	<p><b>Wall Color</b></p> <p>Corrects the projected picture's color when the projection surface such as a painted wall which may not be white, the Wall Color feature can help correct the projected picture's colors to prevent possible color difference between the source and projected pictures. There are several precalibrated colors to choose from: <b>Light Yellow, Pink, Light Green, Blue, and Blackboard.</b></p>
<p><b>Reset Picture</b></p>	<p>Returns all of the adjustments you've made for the <b>Picture</b> menu to the factory preset values.</p>

## Display

<p><b>Aspect Ratio</b></p>	<p>There are several options to set the image's aspect ratio depending on your input signal source.</p> <ul style="list-style-type: none"> <li>• <b>Auto:</b> Scales an image proportionally to fit the projector's native resolution in its horizontal or vertical width.           <div style="display: flex; align-items: center; margin-top: 10px;">  </div> </li> <li>• <b>Real:</b> Projects an image as its original resolution and resizes it to fit within the display area. For input signals with lower resolutions, the projected image will be displayed in its original size.           <div style="display: flex; align-items: center; margin-top: 10px;">  </div> <div style="display: flex; align-items: center; margin-top: 10px;">  </div> </li> <li>• <b>4:3:</b> Scales an image so that it is displayed in the center of the screen with a 4:3 aspect ratio.           <div style="display: flex; align-items: center; margin-top: 10px;">  </div> </li> <li>• <b>16:9:</b> Scales an image so that it is displayed in the center of the screen with a 16:9 aspect ratio.           <div style="display: flex; align-items: center; margin-top: 10px;">  </div> </li> <li>• <b>16:10:</b> Scales an image so that it is displayed in the center of the screen with a 16:10 aspect ratio.           <div style="display: flex; align-items: center; margin-top: 10px;">  </div> </li> </ul>
<p><b>Keystone</b></p>	<p>Corrects any keystone of the image. See <a href="#">Correcting keystone on page 16</a>.</p>
<p><b>Test Pattern</b></p>	<p>Adjusts the image size and focus and check that the projected image is free from distortion.</p> <div style="text-align: right; margin-top: 20px;">  </div>
<p><b>PC &amp; Component YPbPr Tuning</b></p>	<ul style="list-style-type: none"> <li>• <b>Phase:</b> Adjusts the clock phase to reduce image distortion. This function is only available when a PC signal (analog RGB) or YPbPr signal is selected.</li> <li>• <b>H. Size:</b> Adjusts the horizontal width of the image. This function is only available when a PC signal (analog RGB) is selected.</li> </ul> <div style="text-align: right; margin-top: 20px;">  </div>

<p><b>Position</b></p>	<p>Displays the position adjustment page. To move the projected image, use the directional arrow keys. This function is only available when a PC signal (analog RGB) is selected.</p>
<p><b>3D</b></p>	<p>This projector features a 3D function which enables you to enjoy the 3D movies, videos, and sporting events in a more realistic way by presenting the depth of the images. You need to wear a pair of 3D glasses to view the 3D images.</p> <ul style="list-style-type: none"> <li>• <b>3D Mode:</b> The default setting is <b>Off</b>. If you want the projector to automatically choose an appropriate 3D format when detecting 3D contents, select <b>Auto</b>. If the projector cannot recognize the 3D format, press ▲/▼ to choose a 3D mode from among <b>Top Bottom</b>, <b>Frame Sequential</b>, <b>Frame Packing</b> and <b>Side by Side</b>.</li> </ul> <p></p> <p>When 3D function is activated:</p> <ul style="list-style-type: none"> <li>• The brightness level of the projected image will decrease.</li> <li>• The following settings cannot be adjusted: <b>Picture Mode</b>, <b>Reference Mode</b>.</li> <li>• The <b>Keystone</b> can only be adjusted within limited degrees.</li> <li>• <b>3D Sync Invert:</b> When you discover the inversion of the image depth, enable this function to correct the problem.</li> <li>• <b>Apply 3D Settings:</b> After the 3D settings are saved, you can decide if you would like to apply them by choosing a set of 3D settings that you have saved. Once applied, the projector will automatically play the incoming 3D contents if it matches the 3D settings saved.</li> </ul> <p></p> <p>Only the set(s) of 3D settings with memorized data is available.</p> <ul style="list-style-type: none"> <li>• <b>Save 3D Settings:</b> When you have successfully displayed the 3D contents after making the appropriate adjustments, you can enable this function and choose a set of 3D settings to memorize current 3D settings.</li> </ul>
<p><b>HDMI Format</b></p>	<p>Selects a suitable color format to optimize display quality.</p> <ul style="list-style-type: none"> <li>• <b>Auto:</b> Automatically selects a suitable color space and gray level for the incoming HDMI signal.</li> <li>• <b>RGB Limited:</b> Utilizes the Limited range RGB 16-235.</li> <li>• <b>RGB Full:</b> Utilizes the Full range RGB 0-255.</li> <li>• <b>YUV Limited:</b> Utilizes the Limited range YUV 16-235.</li> <li>• <b>YUV Full:</b> Utilizes the Full range YUV 0-255.</li> </ul>
<p><b>Digital Zoom</b></p>	<p>Magnifies or reduces the projected image size. After the <b>Digital Zoom</b> page displays, press <b>ZOOM+/ZOOM-</b> to reduce or magnify the image to a desired size. Press the directional arrows (▲, ▼, ◀, ▶) on the projector or remote control to navigate the picture.</p> <p></p> <p>The picture can only be navigated after it is magnified. You can further magnify the picture while searching for details.</p>

<b>Digital Shrink</b>	Shrinks the image with middle point of the image fixed. 1. Go to <b>Advanced Menu - Display &gt; Digital Shrink</b> and press <b>OK</b> . 2. Press ◀/▶ to reduce the image to a desired size.
<b>Teaching Template</b>	Provides some templates as teaching aids. Teachers can use them for teaching.
<b>Reset Display</b>	Returns all of the adjustments you've made for the <b>Display</b> menu to the factory preset values.

## Network

<b>Wired LAN</b>	See <a href="#">Controlling the projector via LAN on page 25</a> .
<b>AMX Device Discovery</b>	When AMX Device Discovery is On, the projector can be detected by AMX controller.
<b>MAC Address (Wired)</b>	Displays the Mac Address for this projector.

## Settings

<b>Projector Installation</b>	See <a href="#">Choosing a location on page 12</a> .
<b>Remote Receiver</b>	Allows you to enable all the remote receivers or one specific remote receiver on the projector.
<b>Auto Source Search</b>	Allows the projector to automatically search for a signal.
<b>Light Settings</b>	<ul style="list-style-type: none"> <li>• <b>Light Mode:</b> See <a href="#">Setting the Light Mode on page 41</a>.</li> <li>• <b>Custom Brightness:</b> Adjusts the light power manually.</li> <li>• <b>Light Information:</b> Displays the number of hours the light has been used.</li> </ul>

**Operation  
Settings**

**Blank Timer**

Sets the image blank time when there is no action taken on the blank screen, once elapsed the image will return to the screen. If the preset time spans are not suitable for your need, select **Disable**. No matter **Blank Timer** is activated or not, you can press most of the keys on the projector or remote control to restore the picture.

**Reset Filter Timer**

Reset the filter timer if a new filter is replaced.

**Reminder Message**

Sets the reminder messages on or off.

**Auto Blank**

Enables or disables the auto blank function.

**Fan Speed Mode**

In **Fan Speed Mode**, fan will rotate faster to suck in more air to cool down the projector. Sets to **High** when the dust filter is installed.

**High Altitude Mode**

We recommend you use the **High Altitude Mode** when your environment is between 1500 m –3000 m above sea level, and ambient temperature is between 0°C–30°C.



Operation under "**High Altitude Mode**" may cause a higher decibel operating noise level because of increased fan speed necessary to improve overall system cooling and performance.

If you use this projector under other extreme conditions excluding the above, it may display auto shut-down symptoms, which is designed to protect your projector from over-heating. In cases like this, you should switch to High Altitude mode to solve these symptoms. However, this is not to state that this projector can operate under any and all harsh or extreme conditions.



Do not use the **High Altitude Mode** if your altitude is between 0 m and 1500 m and ambient temperature is between 0°C and 35°C. The projector will be over cooled, if you turn the mode on under such a condition.



**Power On/Off Settings**

- **Direct Power On:** Allows the projector to turn on automatically once the power is fed through the power cord.
- **Signal Power On:** Sets whether to turn the projector directly on without pressing  **POWER** or  **ON** when the projector is in standby mode and detects a VGA signal or a HDMI signal with 5V power.
- **Auto Power Off:** Allows the projector to turn off automatically if no input signal is detected after a set period of time to prevent unnecessary waste of light source life.
- **Power Off Timer:** Sets the auto-shutdown timer.

<b>Security Settings</b>	See <a href="#">Utilizing the password function on page 23</a> .
<b>Baud Rate</b>	Selects a baud rate that is identical with your computer's so that you can connect the projector using a suitable RS-232 cable and update or download the projector's firmware. This function is intended for qualified service personnel.
<b>HDMI Equalizer</b>	Adjusts the equalizer gain settings for an HDMI signal. The higher the setting, the stronger the gain value. If there are more than one HDMI port on the projector, select the HDMI port first before adjusting the value.
<b>USB Power Switch</b>	Disables or enables "Type A connector" 5V power output for QCast Mirror HDMI wireless dongle.
<b>Reset Settings</b>	Returns all of the adjustments you've made for the <b>Settings</b> menu to the factory preset values.

## System

<b>Language</b>	Sets the language for the On-Screen Display (OSD) menus.
<b>Standby Settings</b>	<ul style="list-style-type: none"> <li>• <b>Network:</b> <ul style="list-style-type: none"> <li>• <b>Enable Network Standby Mode:</b> Selecting <b>On</b> enables the function. The projector is able to provide the network function in standby mode. Selecting <b>Off</b> disables the function. The projector does not provide the network function in standby mode.</li> <li>• <b>Switch to Normal Standby Mode:</b> Allows the projector to disable the network function after a set period of time after it enters standby mode. For instance, if 20 min is selected, the projector is able to provide the network function for 20 minutes after it enters standby mode. When 20 minutes is up, the projector enters normal standby mode.</li> </ul> </li> </ul>  <p>This function is only available when Enable Network Standby Mode is On.</p> <ul style="list-style-type: none"> <li>• <b>Microphone:</b> Enables the microphone line-out function when the projector is in standby mode.</li> <li>• <b>Monitor Out:</b> Allows the projector to output a VGA signal when it is in standby mode and the <b>PC</b> jack and the <b>MONITOR OUT</b> jack are correctly connected to devices.</li> <li>• <b>Audio Pass Through:</b> The projector can play sound when it is in standby mode and the corresponding jacks are correctly connected to devices. Press ◀/▶ to choose the source that you wish to use. See <a href="#">Connection on page 17</a> for how to make the connection.</li> </ul>
<b>Background Settings</b>	<ul style="list-style-type: none"> <li>• <b>Background:</b> Sets the background color for the projector.</li> <li>• <b>Splash Screen:</b> Allows you to select which logo screen will be displayed during projector start-up.</li> </ul>
<b>Menu Settings</b>	<ul style="list-style-type: none"> <li>• <b>Menu Type:</b> Switches to the <b>Basic</b> OSD menu.</li> <li>• <b>Menu Display Time:</b> Sets the length of time the OSD will remain active after your last key press.</li> </ul>

<p><b>Audio Settings</b></p>	<ul style="list-style-type: none"> <li>• <b>Mute:</b> Temporarily turns off the sound.</li> <li>• <b>Volume:</b> Adjusts the sound level.</li> <li>• <b>Microphone Volume:</b> Adjusts the microphone volume of the projector.</li> <li>• <b>Power On/Off Ring Tone:</b> Turns on or off the ring tone when the projector is in startup and shutdown process.</li> </ul>  <p>The only way to change <b>Power On/Off Ring Tone</b> is setting <b>On</b> or <b>Off</b> here. Setting the sound mute or changing the sound level will not affect the <b>Power On/Off Ring Tone</b>.</p>
<p><b>Closed Caption</b></p>	<ul style="list-style-type: none"> <li>• <b>Closed Caption Enable:</b> Activates the function by selecting <b>On</b> when the selected input signal carries closed captions.</li> </ul>  <p>Captions: An on-screen display of the dialogue, narration, and sound effects of TV programs and videos that are closed captioned (usually marked as "CC" in TV listings).</p> <ul style="list-style-type: none"> <li>• <b>Caption Version:</b> Selects a preferred closed captioning mode. To view captions, select <b>CC1</b>, <b>CC2</b>, <b>CC3</b>, or <b>CC4</b> (<b>CC1</b> displays captions in the primary language in your area).</li> </ul>
<p><b>Factory Default</b></p>	<p>Returns all settings to the factory preset values.</p>  <p>The following settings will still remain: <b>Keystone</b>, <b>Projector Installation</b>, <b>Light Usage Time</b>, <b>Security Settings</b>, <b>Baud Rate</b>, <b>QUICK INSTALL</b>, <b>Filter Usage Time</b>, <b>High Altitude Mode</b>, <b>Fan Speed Mode</b>, <b>HDMI Equalizer</b>.</p>
<p><b>Reset System</b></p>	<p>Returns all of the adjustments you've made for the <b>System</b> menu to the factory preset values.</p>

## Information

<p><b>Information</b></p>	<ul style="list-style-type: none"> <li>• <b>Native Resolution:</b> Shows the native resolution of the projector.</li> <li>• <b>Detected Resolution:</b> Shows the native resolution of the input signal.</li> <li>• <b>Source:</b> Shows the current signal source.</li> <li>• <b>Picture Mode:</b> Shows the selected mode in the <b>Picture</b> menu.</li> <li>• <b>Light Mode:</b> Shows the selected mode in the <b>Light Settings</b> menu.</li> <li>• <b>3D Format:</b> Shows the current 3D mode.</li> <li>• <b>Color System:</b> Shows input system format.</li> <li>• <b>Light Usage Time:</b> Shows the number of hours the light source has been used.</li> <li>• <b>Filter Usage Time:</b> Displays the number of hours the filter has been used.</li> <li>• <b>Firmware Version:</b> Shows the firmware version of your projector.</li> </ul>
---------------------------	--

# Maintenance

## Care of the projector

### Cleaning the lens

Clean the lens whenever you notice dirt or dust on the surface. Please be sure to turn off the projector and let it cool down completely before cleaning the lens.

- Use a canister of compressed air to remove dust.
- If there is dirt or smears, use lens-cleaning paper or moisten a soft cloth with lens cleaner and gently wipe the lens surface.
- Never use any type of abrasive pad, alkaline/acid cleaner, scouring powder, or volatile solvent, such as alcohol, benzene, thinner or insecticide. Using such materials or maintaining prolonged contact with rubber or vinyl materials may result in damage to the projector surface and cabinet material.

### Cleaning the projector case

Before you clean the case, turn the projector off using the proper shutdown procedure as described in [Shutting down the projector on page 29](#) and unplug the power cord.

- To remove dirt or dust, wipe the case with a soft, lint-free cloth.
- To remove stubborn dirt or stains, moisten a soft cloth with water and a neutral pH detergent. Then wipe the case.



Never use wax, alcohol, benzene, thinner or other chemical detergents. These can damage the case.

### Storing the projector

If you need to store the projector for an extended time, please follow the instructions below:

- Make sure the temperature and humidity of the storage area are within the recommended range for the projector. Please refer to [Specifications on page 44](#) or consult your dealer about the range.
- Retract the adjuster feet.
- Remove the battery from the remote control.
- Pack the projector in its original packing or equivalent.

### Transporting the projector

It is recommended that you ship the projector with its original packing or equivalent.



## Light information

### Extending light source life

- Setting the **Light Mode**

Go to **Advanced Menu - Settings > Light Settings > Light Mode** and select a suitable light source power from among the provided modes.

Setting the projector in **Economic, Dimming** or **Custom** mode extends light source life.





























































Light source mode	Description
<b>Normal</b>	Provides full light source brightness
<b>Economic</b>	Lowers brightness to extend the light source life and decreases the fan noise
<b>Dimming</b>	Lowers brightness to offer a longer light source life
<b>Custom</b>	Adjusts the light source power on users selection









- Setting **Auto Power Off**

This function allows the projector to turn off automatically if no input signal is detected after a set period of time to prevent unnecessary waste of light source life.

To set **Auto Power Off**, go to **Advanced Menu - Settings > Power On/Off Settings > Auto Power Off** and press ◀/▶.

## Indicators

Light			Status & Description
POWER ○	TEMP ○	LAMP ○	
<b>System Messages</b>			
			Stand-by mode
			Powering up
			Normal operation
			Normal power-down cooling
			Download
			CW start fail
			Light life exhausted
			LAN download fail
			LAN download processing
<b>Burn-In Messages</b>			
			Burn-in ON
			Burn-in OFF
<b>Light Error Messages</b>			
			Light error in normal operation
			Light is not lit up
<b>Thermal Error Messages</b>			
			Fan 1 error (the actual fan speed is outside the desired speed)
			Fan 2 error (the actual fan speed is outside the desired speed)
			Fan 3 error (the actual fan speed is outside the desired speed)
			Temperature 1 error (over limited temperature)
			Thermal IC #1 I2C Connection error
			Temperature 2 error (over limited temperature)
			Thermal IC #2 I2C Connection error

	 : <b>Off</b>	 : Orange On	 : Green On	 : Red On
		 : Orange Flashing	 : Green Flashing	 : Red Flashing

# Troubleshooting

## ? The projector does not turn on.

Cause	Remedy
There is no power from the power cord.	Plug the power cord into the AC power jack on the projector, and plug the power cord into the power outlet. If the power outlet has a switch, make sure that it is switched on.
Attempting to turn the projector on again during the cooling process.	Wait until the cooling down process has completed.

## ? No picture

Cause	Remedy
The video source is not turned on or connected correctly.	Turn the video source on and check that the signal cable is connected correctly.
The projector is not correctly connected to the input signal device.	Check the connection.
The input signal has not been correctly selected.	Select the correct input signal with the <b>SOURCE</b> key.
The lens cover is still closed.	Open the lens cover.

## ? Blurred image

Cause	Remedy
The projection lens is not correctly focused.	Adjust the focus of the lens using the focus ring.
The projector and the screen are not aligned properly.	Adjust the projection angle and direction as well as the height of the projector if necessary.
The lens cover is still closed.	Open the lens cover.

## ? Remote control does not work.

Cause	Remedy
The batteries are out of power.	Replace both of the batteries with new ones.
There is an obstacle between the remote control and the projector.	Remove the obstacle.
You are too far away from the projector.	Stand within 8 meters (26 feet) of the projector.

## ? The password is incorrect.

Cause	Remedy
You do not remember the password.	See <a href="#">Entering the password recall procedure on page 23</a> .

# Specifications

## Projector specifications



All specifications are subject to change without notice.

### Optical

#### Resolution

1024 x 768 XGA (LX820ST)  
1280 x 800 WXGA (LW820ST)

#### Display system

DLP® Chip

#### Lens

F = 2.79, f = 7.46 mm

#### Offset

LX820ST: 108.4+/-2.5%  
LW820ST: 106.1+/-2.5%

#### Zoom ratio

Fixed

#### Light source

Laser diode

### Electrical

#### Power supply

AC100–240V, 3.00 A, 50–60 Hz (Automatic)

#### Power consumption

321 W (Max); < 0.5 W for normal standby mode;  
<2W (When the Network function in the Standby  
Settings in on)

### Mechanical

#### Weight

5.6 Kg (12.3 lbs)

### Output terminals

#### RGB output

D-Sub 15-pin (female) x 1

#### Speaker

10 watt x 1

#### Audio signal output

PC audio jack x 1

### Control

#### USB

Type-A power supply 5V /1.5 A x 1 (Optional for  
QCast Mirror HDMI Wireless Dongle); Mini-B x 1;  
Micro USB x 1

#### RS-232 serial control

9 pin x 1

#### IR receiver x 2

#### LAN control

Wired (RJ45)

### Input terminals

#### Computer input

RGB input  
D-Sub 15-pin (female) x 2

#### Video signal input

S-VIDEO  
Mini DIN 4-pin x 1  
VIDEO  
RCA jack x 1  
SD/HDTV signal input  
Analog - Component  
(through RGB input)  
Digital - HDMI x 1;  
HDMI/MHL x 1

#### Audio signal input

Audio in  
PC audio jack x 1  
Microphone audio jack x 1  
RCA audio jack (L/R) x 1

### Environmental Requirements

#### Temperature

Operating: 0°C-40°C at sea level  
Storage: -20°C-60°C at sea level

#### Relative humidity

Operating: 10%-90% (without condensation)  
Storage: 10%-90% (without condensation)

#### Altitude

Operating: 0-1499 m at 0°C-35°C;  
1500-3000m at 0°C-30°C (with High Altitude Mode  
on)  
Storage: 0-12200 m at 30°C

#### Transporting

Original packing or equivalent is recommended

#### Repairing

Please visit below website and choose your country to  
find your service contact window.  
<http://www.benq.com/welcome>

## Dimensions

410 mm (W) x 158 mm (H) x 272 mm (D)

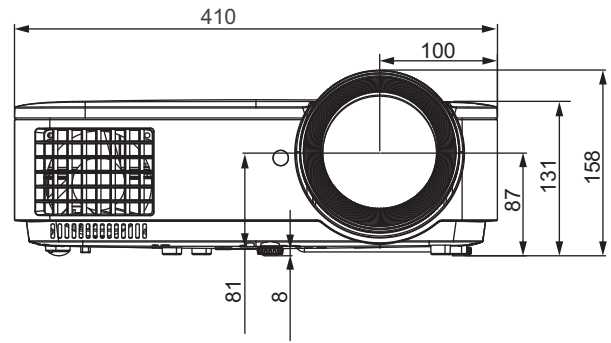
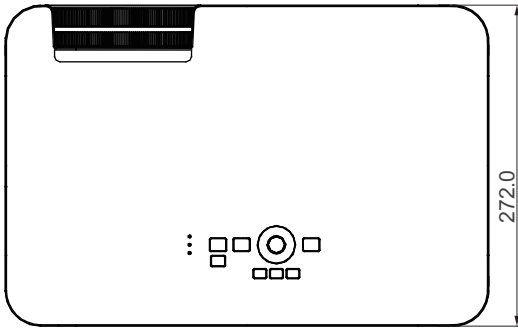

Unit: mm

# Timing chart

## Supported timing for PC input

Resolution	Mode	Vertical Frequency (Hz)	Horizontal Frequency (kHz)	Pixel Frequency (MHz)	Supported 3D format		
					Frame Sequential	Top Bottom	Side by Side
640 x 480	VGA_60	59.940	31.469	25.175	V	V	V
	VGA_72	72.809	37.861	31.500			
	VGA_75	75.000	37.500	31.500			
	VGA_85	85.008	43.269	36.000			
720 x 400	720 x 400_70	70.087	31.469	28.3221			
800 x 600	SVGA_60	60.317	37.879	40.000	V	V	V
	SVGA_72	72.188	48.077	50.000			
	SVGA_75	75.000	46.875	49.500			
	SVGA_85	85.061	53.674	56.250			
	SVGA_120 (Reduce Blanking)	119.854	77.425	83.000	V		
1024 x 768	XGA_60	60.004	48.363	65.000	V	V	V
	XGA_70	70.069	56.476	75.000			
	XGA_75	75.029	60.023	78.750			
	XGA_85	84.997	68.667	94.500			
	XGA_120 (Reduce Blanking)	119.989	97.551	115.5	V		
1152 x 864	1152 x 864_75	75	67.5	108			
1024 x 576	BenQ Notebook_timing	60.0	35.820	46.966			
1024 x 600	BenQ Notebook_timing	64.995	41.467	51.419			
1280 x 720	1280 x 720_60	60	45.000	74.250	V	V	V
1280 x 768	1280 x 768_60	59.87	47.776	79.5	V	V	V
1280 x 800	WXGA_60	59.810	49.702	83.500	V	V	V
	WXGA_75	74.934	62.795	106.500			
	WXGA_85	84.880	71.554	122.500			
	WXGA_120 (Reduce Blanking)	119.909	101.563	146.25	V		
1280 x 1024	SXGA_60	60.020	63.981	108.000		V	V
	SXGA_75	75.025	79.976	135.000			
	SXGA_85	85.024	91.146	157.500			
1280 x 960	1280 x 960_60	60.000	60.000	108.000		V	V
	1280 x 960_85	85.002	85.938	148.500			
1360 x 768	1360 x 768_60	60.015	47.712	85.5		V	V
1440 x 900	WXGA+_60	59.887	55.935	106.500		V	V
1400 x 1050	SXGA+_60	59.978	65.317	121.750		V	V
1600 x 1200	UXGA	60.000	75.000	162.000		V	V
1680 x 1050	1680 x 1050_60	59.954	65.290	146.250		V	V
640 x 480@67Hz	MAC13	66.667	35.000	30.240			
832 x 624@75Hz	MAC16	74.546	49.722	57.280			
1024 x 768@75Hz	MAC19	74.93	60.241	80.000			
1152 x 870@75Hz	MAC21	75.060	68.680	100.000			



The timings showing above may not be supported due to EDID file and VGA graphic card limitations. It is possible that some timings cannot be chosen.

## Supported timing for HDMI (HDCP) input

- PC timings

Resolution	Mode	Vertical Frequency (Hz)	Horizontal Frequency (kHz)	Pixel Frequency (MHz)	Supported 3D format		
					Frame Sequential	Top Bottom	Side by Side
640 x 480	VGA_60	59.940	31.469	25.175	V	V	V
	VGA_72	72.809	37.861	31.500			
	VGA_75	75.000	37.500	31.500			
	VGA_85	85.008	43.269	36.000			
720 x 400	720 x 400_70	70.087	31.469	28.3221			
800 x 600	SVGA_60	60.317	37.879	40.000	V	V	V
	SVGA_72	72.188	48.077	50.000			
	SVGA_75	75.000	46.875	49.500			
	SVGA_85	85.061	53.674	56.250			
	SVGA_120 (Reduce Blanking)	119.854	77.425	83.000	V		
1024 x 768	XGA_60	60.004	48.363	65.000	V	V	V
	XGA_70	70.069	56.476	75.000			
	XGA_75	75.029	60.023	78.750			
	XGA_85	84.997	68.667	94.500			
	XGA_120 (Reduce Blanking)	119.989	97.551	115.5	V		
1152 x 864	1152 x 864_75	75	67.5	108			
1024 x 576@60Hz	BenQ Notebook Timing	60.00	35.820	46.996			
1024 x 600@65Hz	BenQ Notebook Timing	64.995	41.467	51.419			
1280 x 720	1280 x 720_60	60	45.000	74.250	V	V	V
1280 x 768	1280 x 768_60	59.870	47.776	79.5	V	V	V
1280 x 800	WXGA_60	59.810	49.702	83.500	V	V	V
	WXGA_75	74.934	62.795	106.500			
	WXGA_85	84.880	71.554	122.500			
	WXGA_120 (Reduce Blanking)	119.909	101.563	146.25	V		
1280 x 1024	SXGA_60	60.020	63.981	108.000		V	V
	SXGA_75	75.025	79.976	135.000			
	SXGA_85	85.024	91.146	157.500			
1280 x 960	1280 x 960_60	60.000	60.000	108		V	V
	1280 x 960_85	85.002	85.938	148.500			
1360 x 768	1360 x 768_60	60.015	47.712	85.500		V	V
1440 x 900	WXGA+_60	59.887	55.935	106.500		V	V
1400 x 1050	SXGA+_60	59.978	65.317	121.750		V	V
1600 x 1200	UXGA	60.000	75.000	162.000		V	
1680 x 1050	1680 x 1050_60	59.954	65.290	146.250		V	V
640 x 480@67Hz	MAC13	66.667	35.000	30.240			
832 x 624@75Hz	MAC16	74.546	49.722	57.280			
1024 x 768@75Hz	MAC19	75.020	60.241	80.000			
1152 x 870@75Hz	MAC21	75.06	68.68	100.00			
1920 x 1080@60Hz	1920 x 1080_60	60	67.5	148.5	V	V	V
1920 x 1200	1920 x 1200_60 (Reduce Blanking)	59.95	74.038	154	V	V	V



The timings showing above may not be supported due to EDID file and VGA graphic card limitations. It is possible that some timings cannot be chosen.

• Video timings

Timing	Resolution	Vertical Frequency (Hz)	Horizontal Frequency (kHz)	Pixel Frequency (MHz)	Supported 3D format			
					Frame Sequential	Frame Packing	Top Bottom	Side by Side
480i	720 x 480	59.94	15.73	27	✓			
480p	720 x 480	59.94	31.47	27	✓			
576i	720 x 576	50	15.63	27				
576p	720 x 576	50	31.25	27				
720/50p	1280 x 720	50	37.5	74.25		✓	✓	✓
720/60p	1280 x 720	60	45.00	74.25	✓	✓	✓	✓
1080/50i	1920 x 1080	50	28.13	74.25				✓
1080/60i	1920 x 1080	60	33.75	74.25				✓
1080/24P	1920 x 1080	24	27	74.25		✓	✓	✓
1080/25P	1920 x 1080	25	28.13	74.25				
1080/30P	1920 x 1080	30	33.75	74.25				
1080/50P	1920 x 1080	50	56.25	148.5			✓	✓
1080/60P	1920 x 1080	60	67.5	148.5			✓	✓

Supported timing for MHL input

Timing	Resolution	Vertical Frequency (Hz)	Horizontal Frequency (kHz)	Pixel Frequency (MHz)
480i	720 (1440) x 480	59.94	15.73	27
480p	720 x 480	59.94	31.47	27
576i	720 (1440) x 576	50	15.63	27
576p	720 x 576	50	31.25	27
720/50p	1280 x 720	50	37.5	74.25
720/60p	1280 x 720	60	45.00	74.25
1080/24P	1920 x 1080	24	27	74.25
1080/25P	1920 x 1080	25	28.13	74.25
1080/30P	1920 x 1080	30	33.75	74.25
1080/50i	1920 x 1080	50	28.13	74.25
1080/60i	1920 x 1080	60	33.75	74.25
1080/50p	1920 x 1080	50	56.25	148.5
1080/60p	1920 x 1080	60	67.5	148.5

Supported timing for Component-YPbPr input

Timing	Resolution	Vertical Frequency (Hz)	Horizontal Frequency (kHz)	Pixel Frequency (MHz)	Supported 3D format
					Frame Sequential
480i	720 x 480	59.94	15.73	13.5	✓
480p	720 x 480	59.94	31.47	27	✓
576i	720 x 576	50	15.63	13.5	
576p	720 x 576	50	31.25	27	
720/50p	1280 x 720	50	37.5	74.25	
720/60p	1280 x 720	60	45.00	74.25	✓
1080/50i	1920 x 1080	50	28.13	74.25	
1080/60i	1920 x 1080	60	33.75	74.25	
1080/24P	1920 x 1080	24	27	74.25	
1080/25P	1920 x 1080	25	28.13	74.25	
1080/30P	1920 x 1080	30	33.75	74.25	
1080/50P	1920 x 1080	50	56.25	148.5	
1080/60P	1920 x 1080	60	67.5	148.5	



Displaying a 1080i(1125i)@60Hz or 1080i(1125i)@50Hz signal may result in slight image vibration.



## Supported timing for Video and S-Video inputs

Video mode	Horizontal Frequency (kHz)	Vertical Frequency (Hz)	Color sub-carrier Frequency (MHz)	Supported 3D format
				Frame Sequential
NTSC	15.73	60	3.58	V
PAL	15.63	50	4.43	
SECAM	15.63	50	4.25 or 4.41	
PAL-M	15.73	60	3.58	
PAL-N	15.63	50	3.58	
PAL-60	15.73	60	4.43	
NTSC4.43	15.73	60	4.43	